

CLOSURES AND  
JOINERY

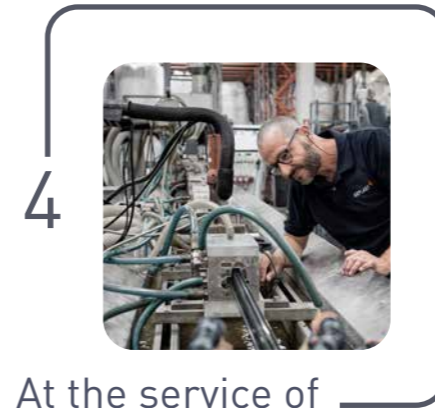

At the service of  
your projects

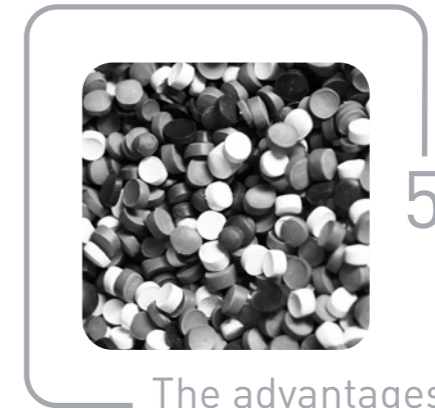

The advantages  
of PVC



**GEKO**  
Eco-designed by nature

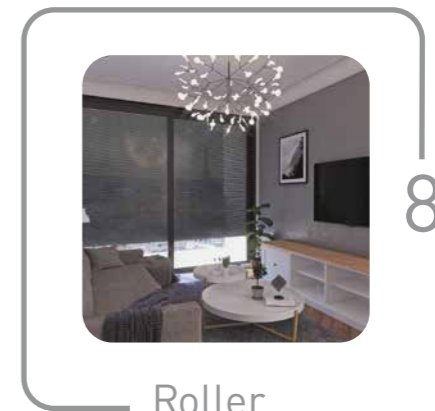

Roller  
shutters

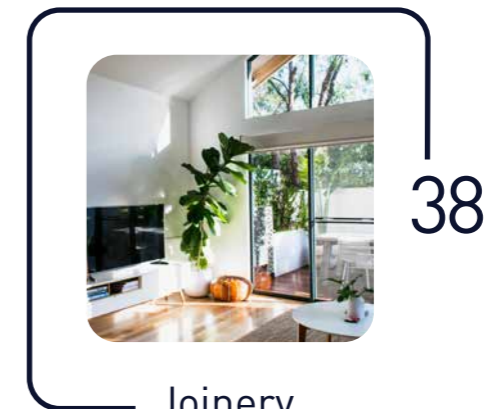

Joinery

# At the service of your projects

For over 20 years, our team has been dedicated to your projects. Thanks to our expertise in the design and extrusion of profiles, we are able to offer you quality products, innovative and efficient solutions to meet all your expectations.

Geplast Building brings together the entire product range for building professionals in the field of joinery and closure.

Some of our PVC profiles are certified QB59 (mass-coloured finish profiles) and QB33 (profiles with plaxed finish) by the CSTB. For more information, please visit our website : [www.geplast.fr](http://www.geplast.fr).

## Our expertise



Design of the specifications

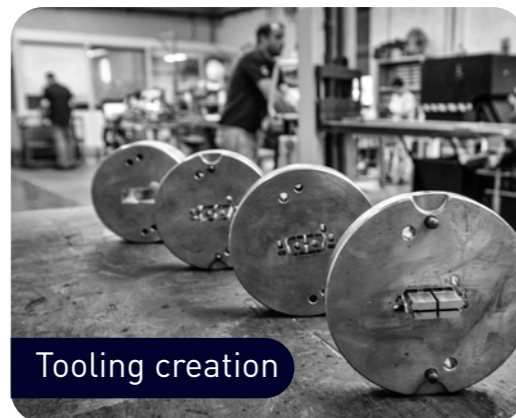

Tooling creation



Profile extrusion



Finishing plating, bending



Logistics



Recycling

# The advantages of PVC

It contains less petroleum than other major thermoplastics and therefore has a much smaller carbon footprint. 100% recyclable, insulating and durable over time, PVC brings performance and resistance to our products.



### THERMAL INSULATION

Both flexible and rigid, PVC has excellent insulating thermal and phonic properties.



### GOOD VALUE FOR MONEY

PVC is one of the most competitive materials on the market. Less expensive than wood and aluminum, the manufacture of PVC remains simple and its use is multiple.

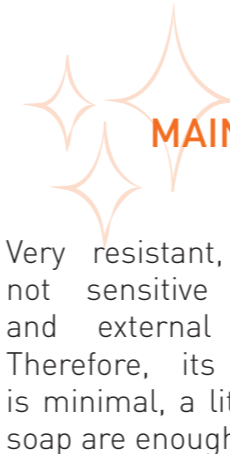

### MAINTENANCE

Very resistant, the PVC is not sensitive to pollution and external aggressions. Therefore, its maintenance is minimal, a little water and soap are enough.

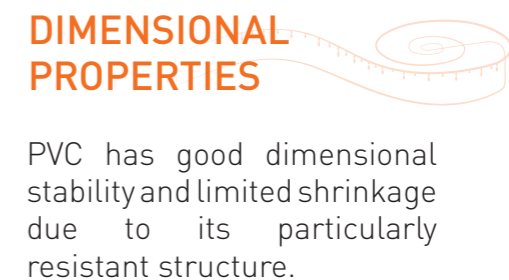

### DIMENSIONAL PROPERTIES

PVC has good dimensional stability and limited shrinkage due to its particularly resistant structure.

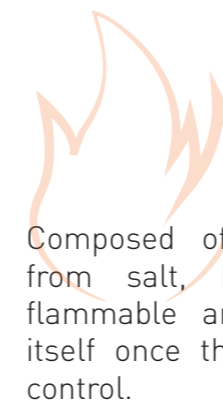

### FIRE REACTION

Composed of 57% chlorine from salt, PVC is hardly flammable and extinguishes itself once the fire is under control.

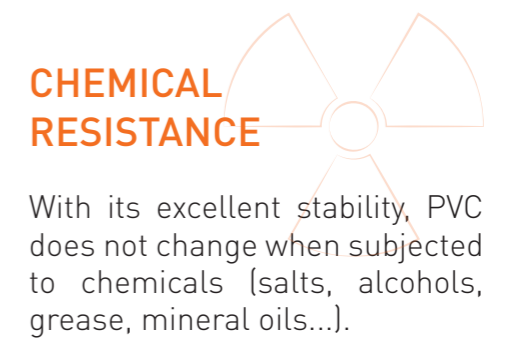

### CHEMICAL RESISTANCE

With its excellent stability, PVC does not change when subjected to chemicals (salts, alcohols, grease, mineral oils...).



From the outset, the products in the GEKO range are part of a **decarbonized and sustainable life cycle**. As a matter of principle, and as far as possible, recycled materials will be used. **All offcuts are sorted, crushed and re-extruded.** In addition to recycled material, GEKO uses alternative composites, from almost inexhaustible agricultural resources or bio-sourced materials.

Similar to a "gecko", a type of lizard found in many parts of the world, the products in the range meet three basic requirements :

- **eco-responsibility** → nature
- **product quality** → agility
- **customized solutions** → great adaptability

A symbol of Geplast's commitment to environmental protection, GEKO is a new green experience in the history of building, simply because it is "**Eco-designed by nature**".

#### REFLECTION & DESIGN

Reflection is the starting point for the design of a product. So we think about the composition of the products, the technical performances we want to obtain as well as the materials to use. The goal is to reduce our environmental footprint as much as possible.

#### RESOURCES CHOICE

- **100% recycled PVC**, obtained through the management of our offcuts transformed into extruded co-products or from our local recycling partners.
- Use of bio-sourced materials such as Loryza®. Composed of **60% natural material** (rice husk), it contains a much lower proportion of petroleum than virgin PVC.

At Geplast, 200 tons of recycled material are used per month to make our products, representing **37%** of our total production.

*For example, the proportion of recycled material in our new IrYs box is **98%**, more than **80%** in our window treatments and **60%** for our products made of Loryza® material for the outdoor range.*

#### TRANSFORMATION EXTRUSION

We favor co-extrusion\* for the development of our GEKO products.

The visible outside is made of 0.5 mm of virgin material to keep the technical aspects on the surface and the inside is made of recycled material.

The eco-design of our products also involves thinking about energy savings, for example by changing the cooling system of our machines. They will be more energy efficient.

*\*This extrusion process makes it possible to obtain a product combining two different formulations to form a single product.*

#### DELIVERY TO CUSTOMERS

To limit our carbon footprint, our deliveries are optimized to avoid round trips.

#### USE

Our customers generate co-products which we recover and purchase for re-use.

#### END OF LIFE RECYCLING

The lifespan of PVC products is 30 years. They are then recovered and recycled by waste treatment companies. Once this step is completed, Geplast takes back the recycled material to create new profiles and products.

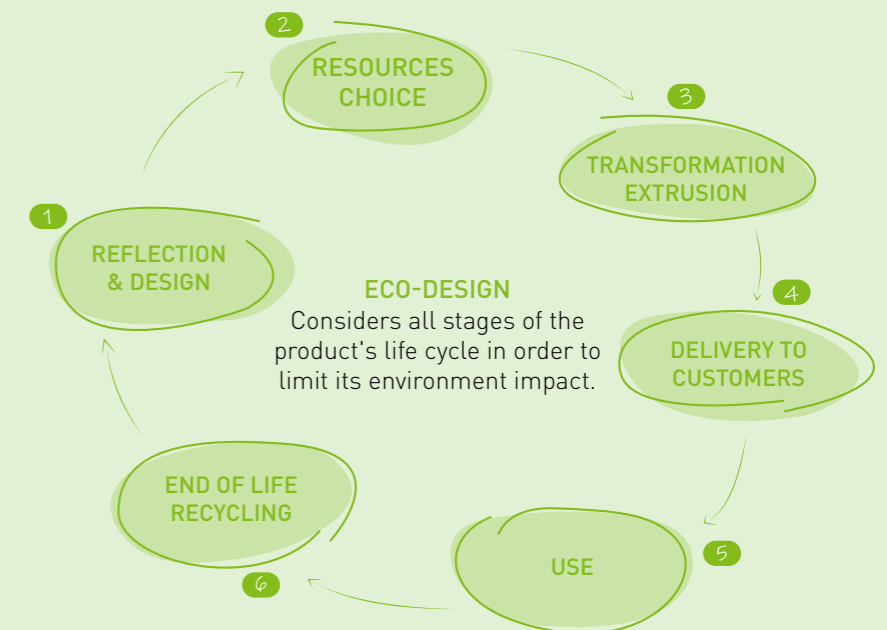

#### REDUCING OUR CARBON FOOTPRINT

The eco-design of our products also involves reducing our carbon impact. Since 2018, Geplast's R&D department and the firm EVEA have been conducting a study to calculate the carbon costs of our recycled materials and measure the energy consumption of some of our extrusion lines. This questioning is formalised by the EPR, which was introduced in 2023 and which should over the years require manufacturers to carry out Life Cycle Analyses (LCAs) in order to produce Environmental and Health Declaration Sheets (EHSDs) for each product, which will be published in the Inies database and checked by inspection bodies.



At Geplast, we have obtained EcoVadis certification, an international label that assesses companies' CSR performance in four areas: **environment, social, ethics and responsible procurement.**

This certification marks a key milestone in our eco-responsible approach. It validates the actions already taken within our company and encourages Geplast to continue its efforts to combine innovation, competitiveness and responsibility.

For us, being EcoVadis certified is a way of guaranteeing our customers, partners and employees that our CSR commitments are concrete, monitored and independently assessed

#### MORE LABEL

For the sixth year running, Geplast has been awarded the first European label recognising our commitment to reducing the environmental footprint associated with the manufacture of our products by promoting the use of recycled raw materials.

Awarded by the French Plastics and Composites Federation (Fédération de la Plasturgie et des Composites), the MORE label (MO bilisés pour RE cyclier) is proof of our progress in incorporating recycled materials into the production of our profiles.



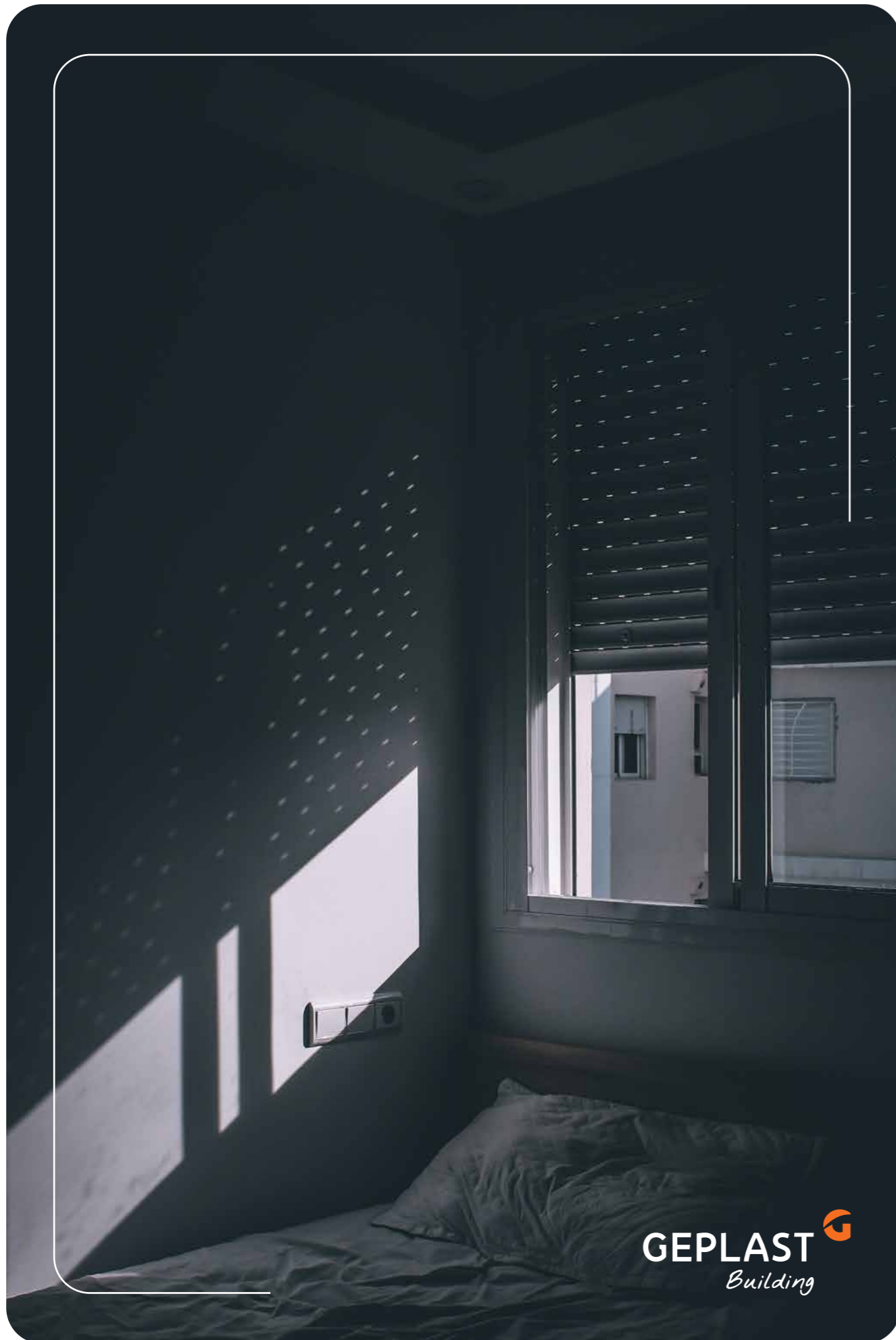

# ROLLER SHUTTERS

- 10 | Our range of boxes
- 12 | IrYs®
- 16 | FoKus®
- 20 | Reno City®
- 22 | GVR.r
- 24 | GVR.e
- 26 | Lame Bioclimatique®
- 34 | Guides
  - > PVC
  - > ALU
- 36 | Practical guide
- 38 | Oktogo® range

# Our range of boxes

Geplast offers the widest range of roller shutter boxes on the market, in order to respond to all installation problems. Whether for new construction or renovation, whatever your joinery, you will find a solution adapted to your situation.



The technical specifications of each box are available in PDF format on request. Please contact our customer service.

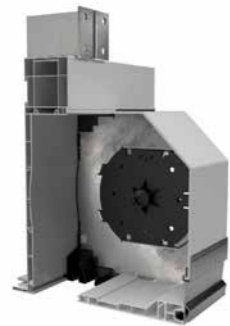

## IrYs® HALF-LINTEL BOX

Made from 98% recycled material.

It meets the requirements of sustainable construction and the RE2020.

The first box on the market to obtain a technical opinion for window widths of up to 3.50 m.



## FoKus® INTERIOR WINDING BOX

Available in 3 sizes :  
168, 205 and 235 mm

FoKus® perfectly meets the new energy standards : thermal, acoustic and aeraulic. These values are certified by PV of the CSTB and the FCBA.



## GVR.r PVC EXTERIOR RENOVATION BOX

Access to the mechanism from the inside, ideal for collective housing.

Preserves the intrinsic performance of the joinery.

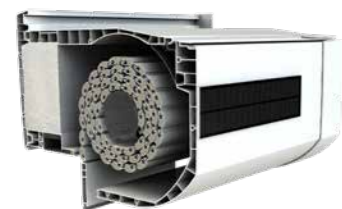

## Reno City® EXTERIOR RENOVATION BOX

Perfect for the renovation of your buildings.

Ideal with solar motorization use.



## GVR.e EXTERNAL WINDING BOX

Ideal for new generation buildings with thermal insulation from the outside.

Adaptation on all PVC, ALU and WOOD joineries.



PATENTED SYSTEM



IrYs  
n°6/22-2433\_V1 - Published on 18/06/2025  
End of validity on 31/07/2028

FDES n°32377



IRYS  
BOX IN  
VIDEO



IrYs®

### HALF-LINTEL BOX

Designed to be part of a sustainable construction approach, the new IrYs half lintel box is made from **98% recycled material**.

It therefore meets the challenges of the **RE2020** (lowcarbon construction) and offers genuine **thermal and acoustic insulation and airtightness performance** for the end user.



### CERTIFIED PERFORMANCE

**THERMAL** :  $U_p = 0,64 \text{ W/m}^2 \cdot \text{K}$  as 120 mm fixed frame

**ACOUSTIC** :

$D_{n,e,w} + C_{tr}$  56 dB in standard configuration,

$D_{n,e,w} + C_{tr}$  59 dB with options

$D_{n,e,w} + C_{tr}$  55 dB in standard configuration with the ventilation grid (PV CSTB)

**AEREAULIC** :

Air flow : **C\*4** with winch and motor (PV CSTB)

Wind : **V\*4** opening widths of 3.5 m with support lugs RF038 (PV CSTB)

**1<sup>st</sup> roller shutter box on the market to obtain technical approval for window widths of up to 3.50 m**

### SOLAR PROTECTION



IrYs® ZIP  
Blind screen



IrYs®  
Lame Bioclimatique®



IrYs®  
BSO SLAT

### INSTALLATIONS

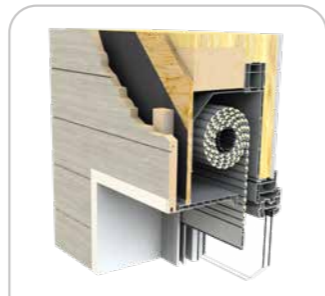

Installation on  
timber-frame house

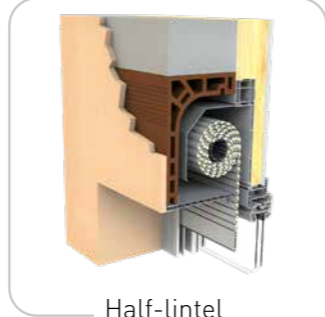

Half-lintel  
installation

### PLANKS IRYS® (200 MM) FOR HALF LINTEL INSTALLATION

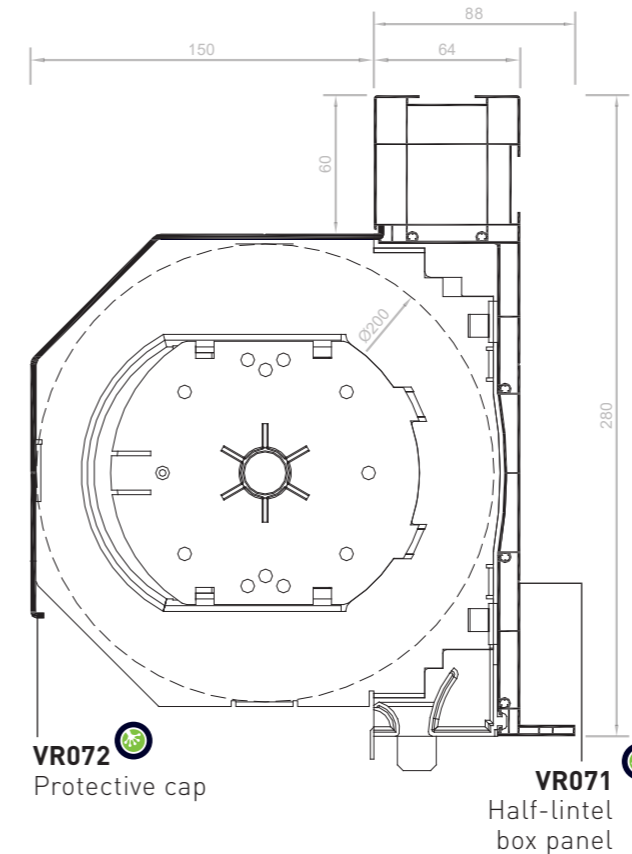

### PLANKS IRYS® (160 MM) FOR INSTALLATION ON TIMBERFRAME HOUSE AND EXTERIOR THERMAL INSULATION

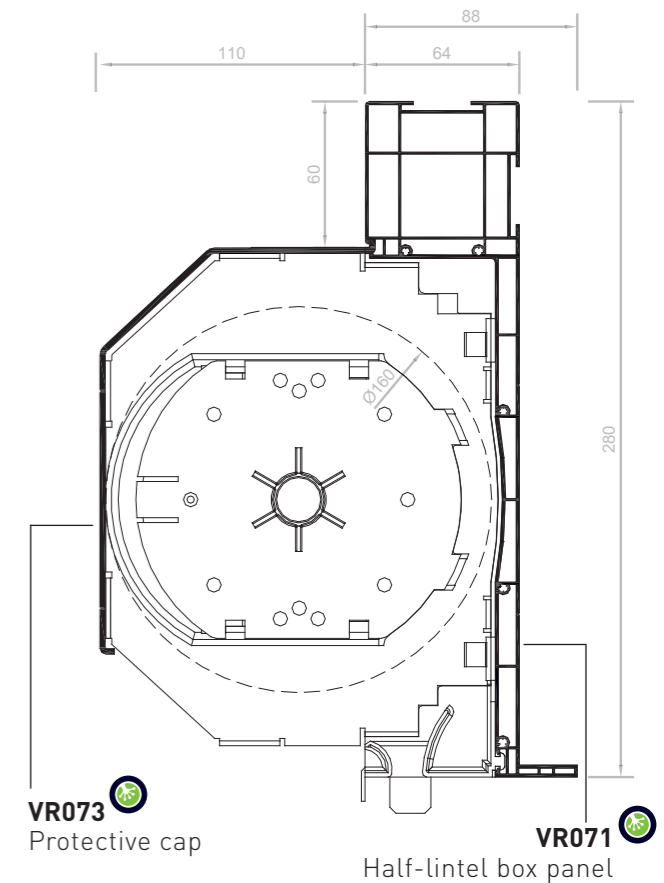

### A TECHNICAL RESPONSE

IrYs® is mainly suitable for two types of installation :

- Traditional masonry with maximised winding at  $\varnothing 200$ ,
- Timber frame with maximised winding at  $\varnothing 160$ .

It is compatible with all types of solar protection : **Lame Bioclimatique®**, long-span slats for **XXL bays** up to **3.50 m**, standard market slats, **BSO** and **insect screens** (better management of solar gain, avoids overheating in buildings in summer and considerably reduces the use of air conditioning).

The assembly of this patented box is fast and industrial:

- simple clipping of end caps, brackets and integration of tulips and brackets (no screws and no silicone),
- the support lugs system is easy to install, there is no need for steel reinforcement,
- after-sales service is facilitated by the removable drawers

### PACK SIZES

	VR071	VR072	VR073
Bars of 6 ml / pack	2	2	2
Bars of 6 ml / container	30	100	150
Bars of 6 ml / half container	-	50	-

### COLORS OF UNDERSIDES "FLORAL"

The "Floreal" colour is derived from the recycling of unused resources in production. The boards can therefore take on different shades.

**NEW**  
**MONOBLOCK UNDERSIDES**

**VR078**  
Underside panel 183 mm  
5 bars of 6 ml / pack  
87 bars of 6 ml / container

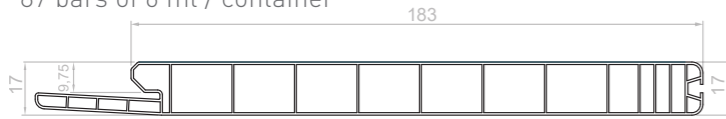

**VR079**  
Underside panel 198 mm  
5 bars of 6 ml / pack  
87 bars of 6 ml / container



**UNDERSIDES 8MM**

**VR057**  
Underside panel 200 mm  
4 bars of 6 ml / pack  
108 bars of 6 ml / container



**VR058**  
Underside panel 185 mm  
4 bars of 6 ml / pack  
108 bars of 6 ml / container



**VR060**  
Underside panel 193 mm  
4 bars of 6 ml / pack  
108 bars of 6 ml / container

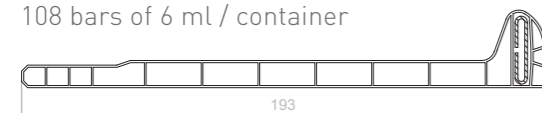

**UNDERSIDES & RAIL COVER COLORS**

*A difference in finish between the underside and the rail cover may exist for dark mass-colored colors.*

**MASS COLOURED**

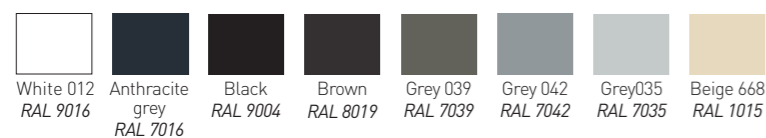

**PLAXED**



*80+ plated film decors available upon request*

The new undersides are more robust thanks to their 17mm thickness.

They feature an integrated rail-hiding spoiler to optimize inventory and logistics.

They fit all tunnel and 1/2-tunnel boxes.

*To avoid warping, we recommend storing the undersides in a dark place, flat along the entire length of the profile.*

**RAIL COVER UNDERSIDES 8MM**

**VR061**  
Patented universal finishing profile  
18 bars of 6 ml / pack

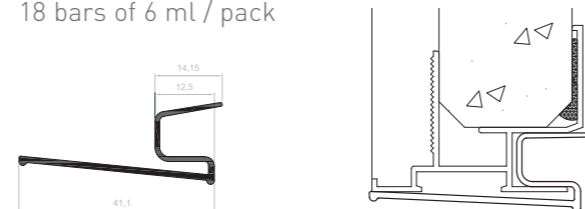

*Patented universal concept*

**ACCESSOIRES**

**RF023**  
Steel underside stiffener  
10 bars of 6 ml / pack

*Significantly improves the inertia and deflection of the underside.*

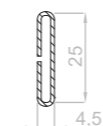

**NEW**  
**ANGLE BRACKET AC099 FOR UNDERSIDES**

The new AC099 underside reinforcement bracket for tunnel and half-lintel boxes has been designed to eliminate deformation on long lengths. Compatible with our range of fascias and finishing profiles, it is screwed directly into the box (pre-drill if using non-self-drilling screws). Plus, AC099 is made from 100% recycled material.

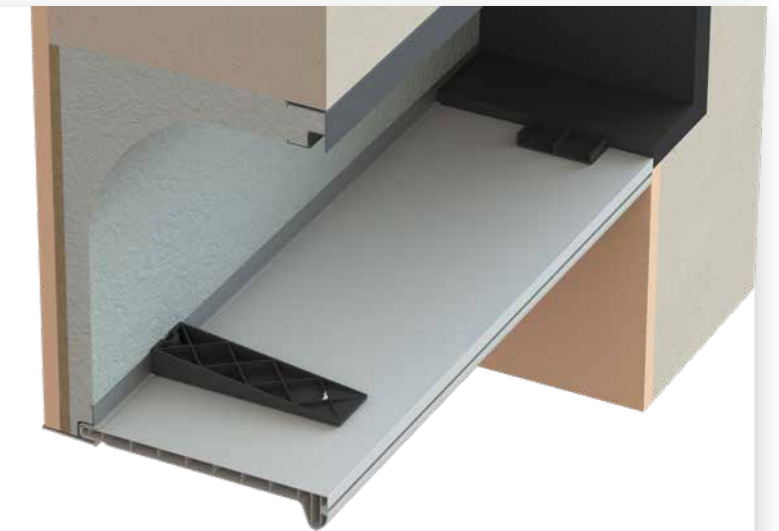

**Colors**  
Black

**AC099\_N0004**  
Reinforcement bracket  
100 pieces / box

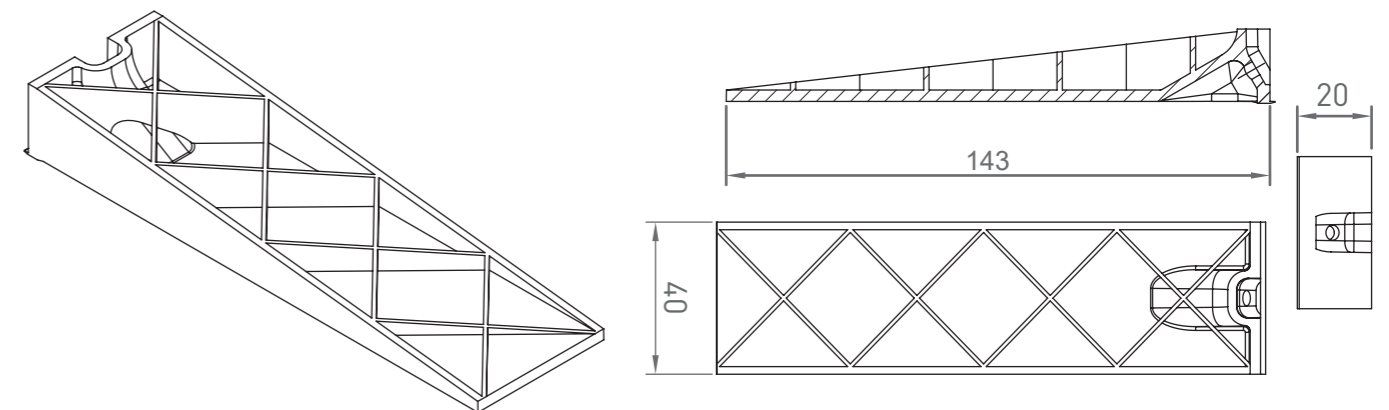

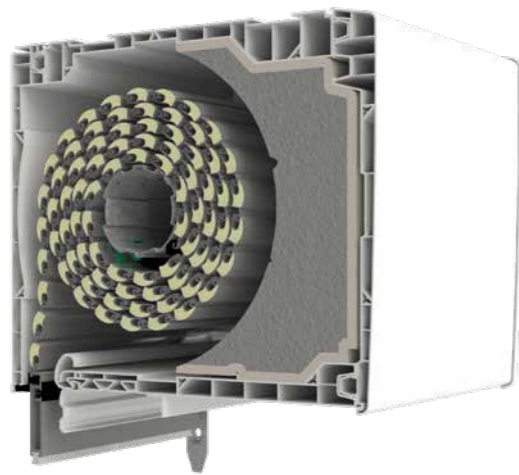

ACERMI n°20/256/1488/1

# FoKus®

## INTERIOR WINDING BOX

FoKus® is available in 3 sizes :  
168, 205 and 235 mm.

## A TECHNICAL RESPONSE

The FoKus® box has several features. **It can be installed on all types of joinery** thanks to the patented universal adaptor concept. Compatible with all maneuvers, it can be used with PVC or ALU aprons and rails

FoKus® is compatible with **the bioclimatic slat** and can also accommodate a **BSO (Solar shading)**. It also has the option of **"Underside access"** to facilitate maintenance work from the inside.

Customizable thanks to its many available finishes (mass-coloured, plaxed or aluminum filmed).

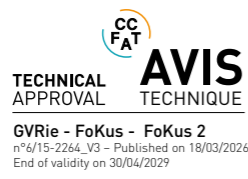

GVRie - FoKus - FoKus 2  
n°4/15-2264\_V3 - Published on 18/03/2026  
End of validity on 30/04/2029

## SOLAR PROTECTION



Fokus® ZIP  
Blind screen

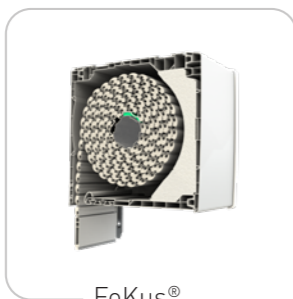

Fokus®  
Lame Bioclimatique®



Fokus®  
BSO SLAT

## INSTALLATIONS

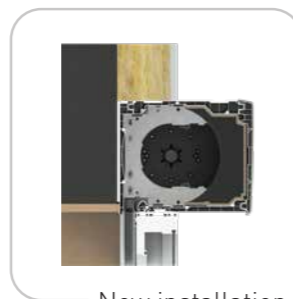

New installation

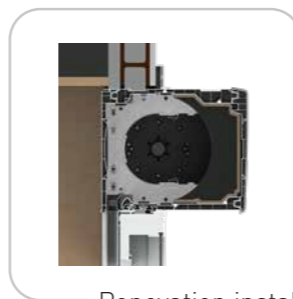

Renovation installation



Installation as  
external thermal  
insulation

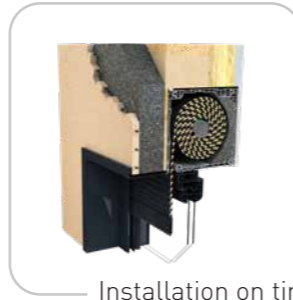

Installation on timber-  
frame house

### COLORS OF THE PLANKS MASS COLOURED

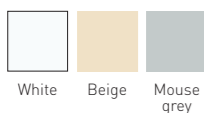

### PLAXED

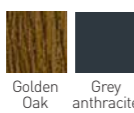

### ALUMINIUM FILMED (except trunk 235 mm)



80+ plated film decors  
available upon request

**FOKUS®**  
BOX IN  
VIDEO



## CERTIFIED PERFORMANCE

### THERMAL :

Uc = 0,76W/m².K. with 120 mm frame (FoKus 168 mm)  
Uc = 0,82W/m².K. with 120 mm frame (FoKus 205 mm)  
Uc = 1,32W/m².K. with 120 mm frame (FoKus 235 mm)

### ACOUSTIC :

Dn,e,w + Ctr up to 53 dB without heavy mass bonding (PV FCBA)

### AERAULIC :

Air flow : C\*4 with motor, winch and TSL and C\*3 with strap  
Wind : V\*4 in 3 ml width

### DURABILITY TESTS :

1,000 pressure/vacuum cycles without screwing down the inner reinforcement



The FoKus® interior roller shutter box range combines all the requirements for tomorrow's buildings by reducing its overall impact on human health (solar gain management, perfect air tightness, maximum acoustic comfort) and on the environment (high thermal insulation and product recycling at the end of its life).

FoKus® reached **53 dB** without heavy mass bonding (PV FCBA)

It thus perfectly meets the new energy standards: **thermal, acoustic and aeraulic**. These values are certified by the PV of the FCBA.

## FOKUS® 205 MM

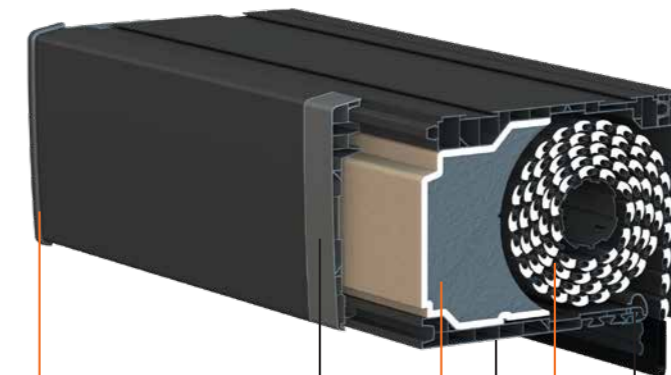

**ALUMINIUM FILMED**  
PVC box panels covered  
by aluminium sheet.

**UNIVERSAL ADAPTOR**  
Patented set of 4 interfaces and  
an underside to adapt to all joinery  
ranges.

**THERMO-ACOUSTIC COMPLEX**  
Patented, it combines acoustic  
attenuation while maintaining a high  
thermal level.

**BRACKET / SLIDE**  
Facilitates maintenance or  
modernisation work.

**OPTION : UNDERSIDE ACCESS**  
Provides easy and rapid access to  
all the interior of the box.

**BIOCLIMATIC SLAT - PVC OR ALU**  
Micro-perforated, it provides more than  
4 times the daylight and ventilation  
than a standard slat.

**PLANKS  
FOKUS® 168 MM**

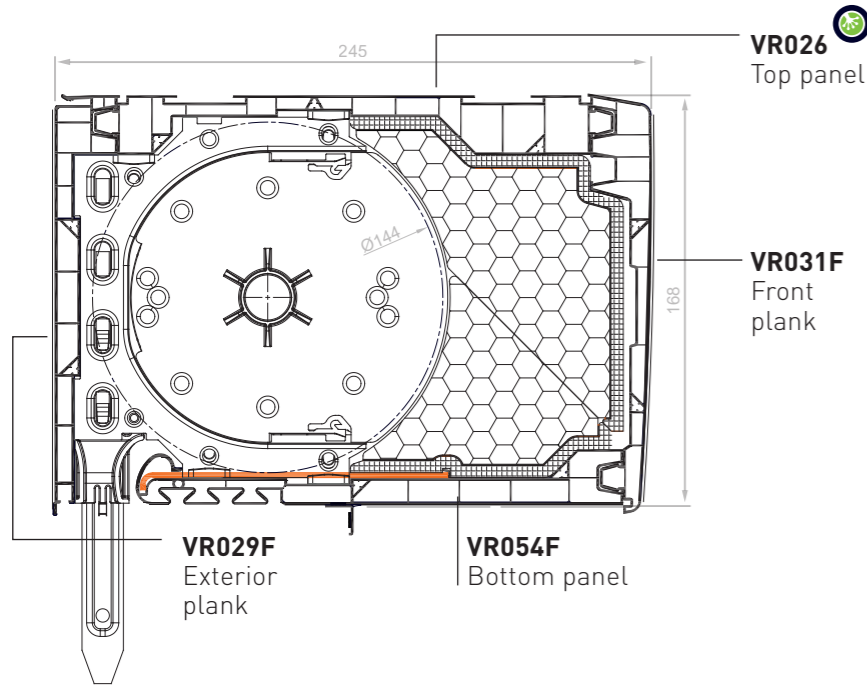

**PLANK KITS  
168 MM**  
**VRKI1C**  
4 planks kit :  
VR026 + VR029F + VR031F + VR054F  
1 kit / pack  
18 kits / container

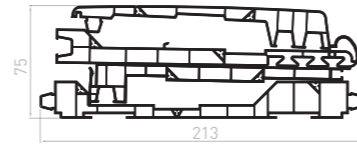

**VRKI1CE**  
Two-colour 4 panels kit:  
3 white PVC panels VR026  
+ VR031F + VR054F  
and coated exterior facade VR029  
(standard colors available)  
1 kit / pack  
18 kits / container

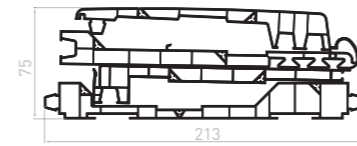

**PLANKS  
FOKUS® 205 MM**

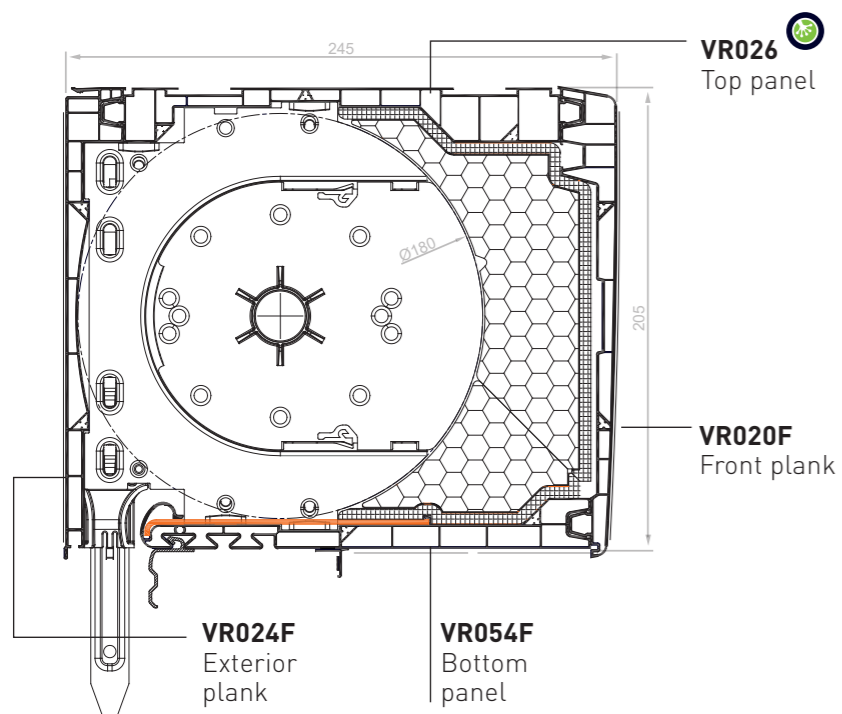

**PLANK KITS  
205 MM**  
**VRKI2C**  
4 planks kit :  
VR020F + VR024F + VR026 + VR054F  
1 kit / pack  
18 kits / container

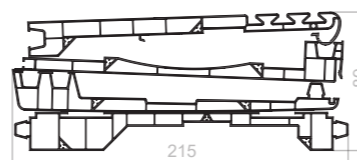

**VRKI2CE**  
Two-colour 4 planks kit :  
3 white PVC panels VR020F +  
VR026 + VR054F  
and coated exterior facade VR024  
(standard colors available)  
1 kit / pack  
18 kits / container

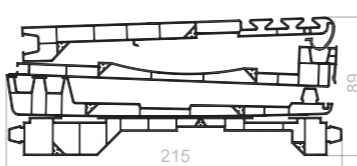

**PACK SIZES**

	VR020F	VR024F	VR026	VR029F	VR031F	VR054F
Bars of 6 ml / pack	4	4	4	4	4	4
Bars of 6 ml / container	72	90	74	120	108	96

**PLANKS FOKUS® 235 MM**

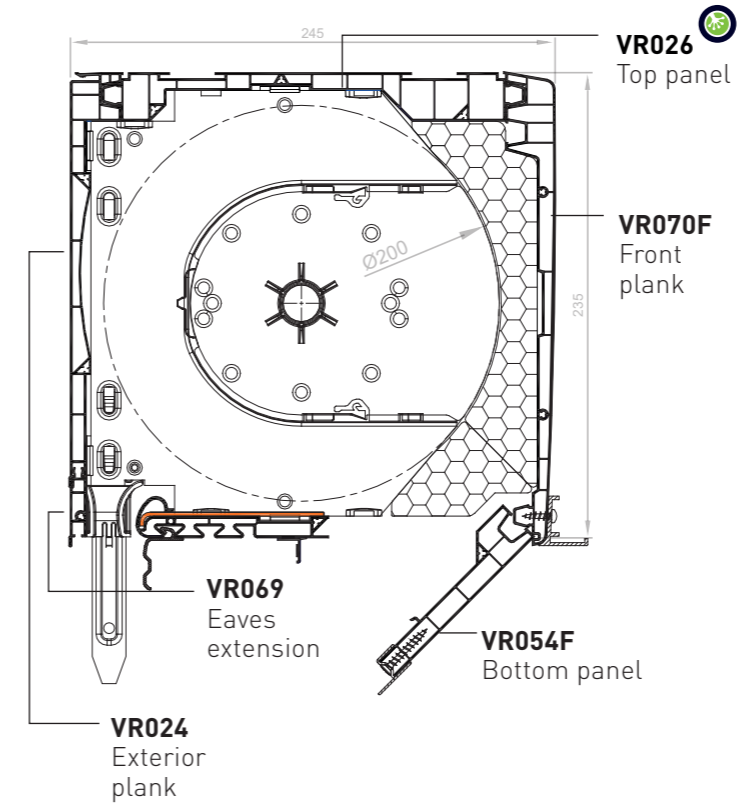

**PLANK KITS  
235 MM**  
**VRKI3C**  
5 planks kit :  
VR024 + VR026 + VR054F + VR069 + VR070  
1 kit / pack  
16 kits / container

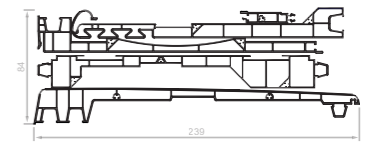

**VRKI3CE**  
Two-colour 5 planks kit :  
VR070F + VR026 + VR054F and coated  
exterior facade VR024 and VR069  
1 kit / pack  
16 kits / container

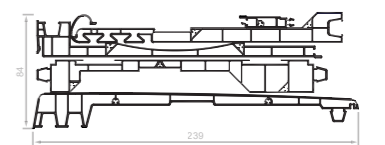

**PLANKS FOKUS® 235 MM  
WITH BSO**

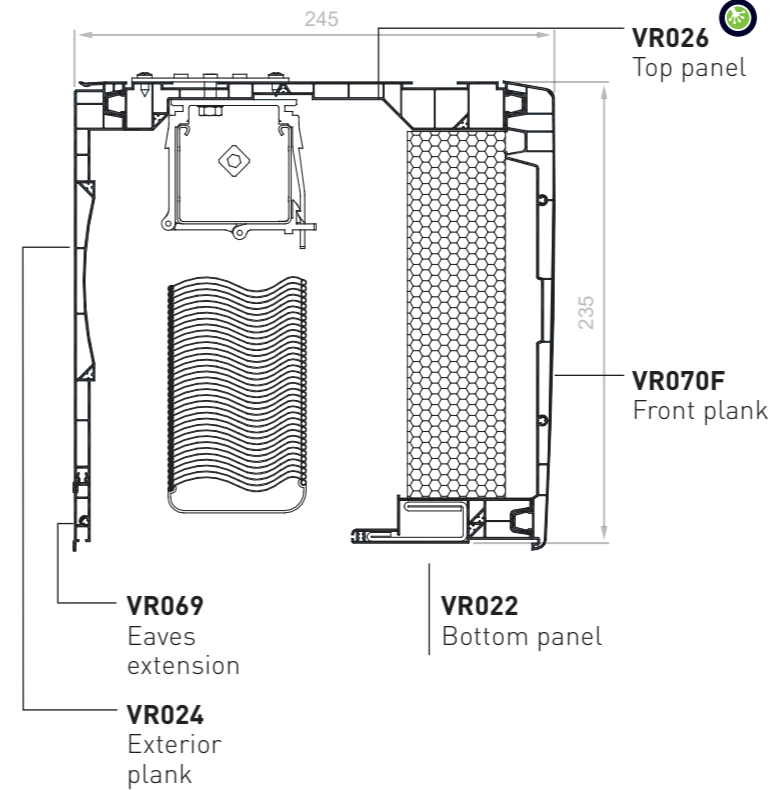

**VRKI3D - SWIVELLING SUNSHADE  
INTEGRATION KIT VERSION**  
5 planks kit :  
VR022 + VR024 + VR026 + VR069 + VR070  
1 kit / pack  
16 kits / container

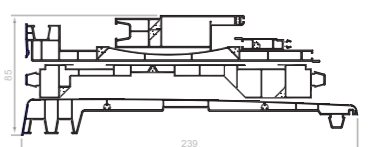

**PACK SIZES**

	VR022	VR024	VR026	VR054F	VR069	VR070F
Bars of 6 ml / pack	4	4	4	4	10	4
Bars of 6 ml / container	160	90	74	96	-	66

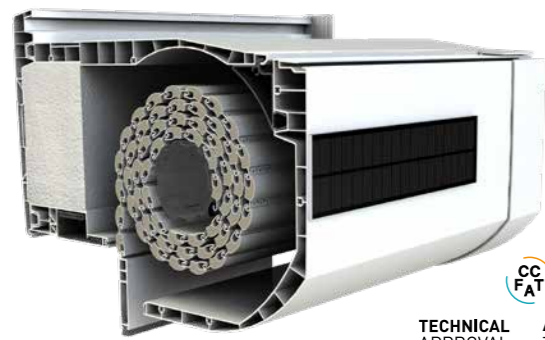

# Reno City®

## LET'S RENOVATE THE CITY OF TOMORROW

3 active patents on the box.  
Ideal for the renovation of your buildings.



### A TECHNICAL RESPONSE

Under technical approval, the Reno City® is characterized as a compact box offering a **144 mm clear glazing**, while maintaining a maximum roll-up diameter of **170 mm**. Moreover, it has an **excellent thermal and acoustic insulation**.

Equipped with an integrated ALU stiffener, it allows **the realization of large width boxes (3 ml)** with a plaxed finish.

Another advantage is **the integration of a drawer, which facilitates maintenance intervention**, and the patented clip-on system of the brackets, which allows the use of narrow slides. It also accepts all market maneuvers and is **ideal for solar motorization use**.

### THE CHOICE OF THE SOLAR MOTORIZATION

Reliable and easy to install, the solar motorization has many advantages and is perfectly integrated into the Reno City®.

Installed in the box, the solar motorization works with a sensor that charges the battery and powers the motor. With its integrated solar motorization, Reno City is **the only window box on the market** to offer **a completely independent window-cabinet installation that is disconnected** from the home's general electronic system.

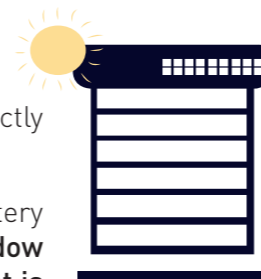

### COLORS OF THE PLANKS MASS COLOURED

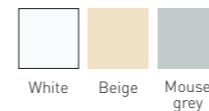

### PLAXED

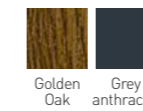

80+ plated film decors available upon request

### PLANKS - RENO CITY®

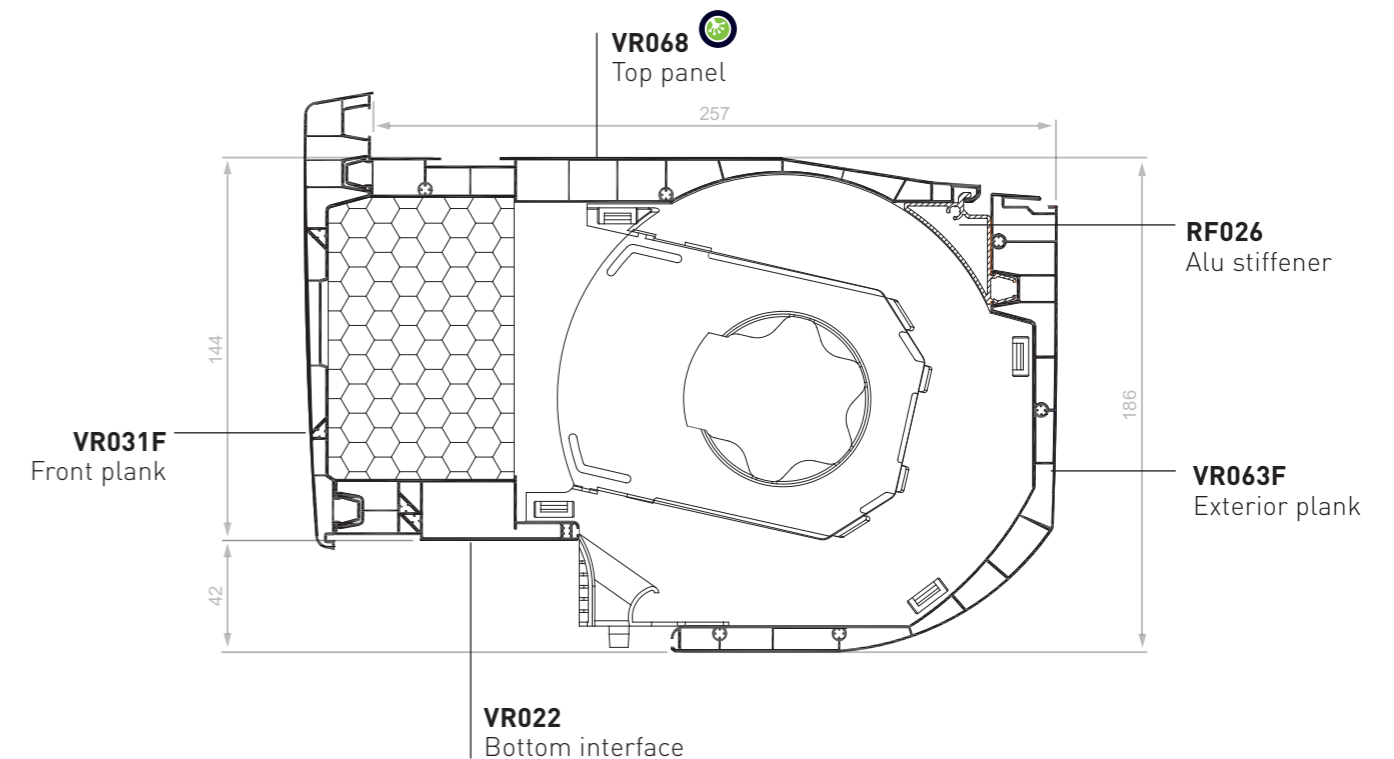

### PACK SIZES

	VR022	VR031F	VR063F	VR068	RF026
Bars of 6 ml / pack	4	4	2	4	4
Bars of 6 ml / container	160	108	30	72	-

### SOLAR PROTECTION



Reno City® ZIP - Blind screen



Reno City® Lame Bioclimatique®

### INSTALLATIONS

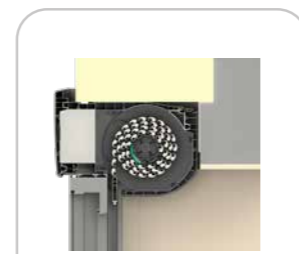

Installation as external thermal insulation

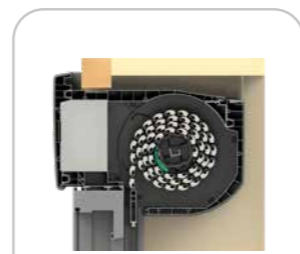

Renovation installation



Installation on timber-frame house

### CERTIFIED PERFORMANCE

#### THERMAL :

Uc = 1,03 W/m².K. with standard EPS

Uc = 0,67 W/m².K. with reinforced thermal insulation made of graphite EPS

ACOUSTIC : Dn,e,w + Ctr 45 dB standard and up to 51 dB

AIR FLOW : C\*4 (AT Value)

WIND : V\*4 with opening width up to 3 m (AT Value)



RENO CITY  
BOX IN VIDEO





# GVR.r

## PVC EXTERIOR RENOVATION BOX

For easier installation and maintenance.

### A TECHNICAL RESPONSE

The GVR.r box is assembled independently of the joinery and is fixed directly by screwing (0 silicone, 0 fixing bracket).

The maintenance of the mechanism is facilitated thanks to **the access from the inside**. Its winding diameter is **160 mm** and it can be operated by winch, motor and solar motorization.

### SOLAR PROTECTION



GVR.r  
Lame Bioclimatique®

### INSTALLATIONS

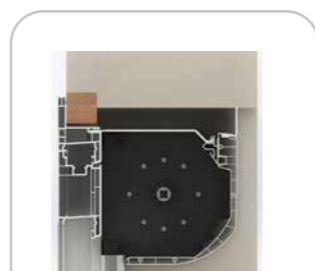

Renovation installation

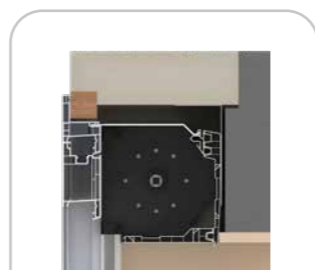

Installation as external thermal insulation

### CERTIFIED PERFORMANCE

The GVR.r box preserves the intrinsic performance of joinery.

## PLANKS - GVR.R

### RENOVATION INSTALLATION

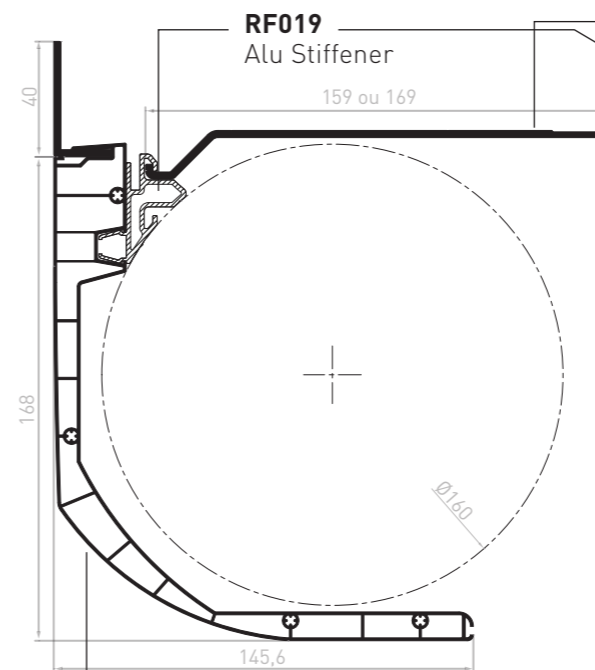

VR063F  
Front plank

### EXTERNAL THERMAL INSULATION RENOVATION INSTALLATION

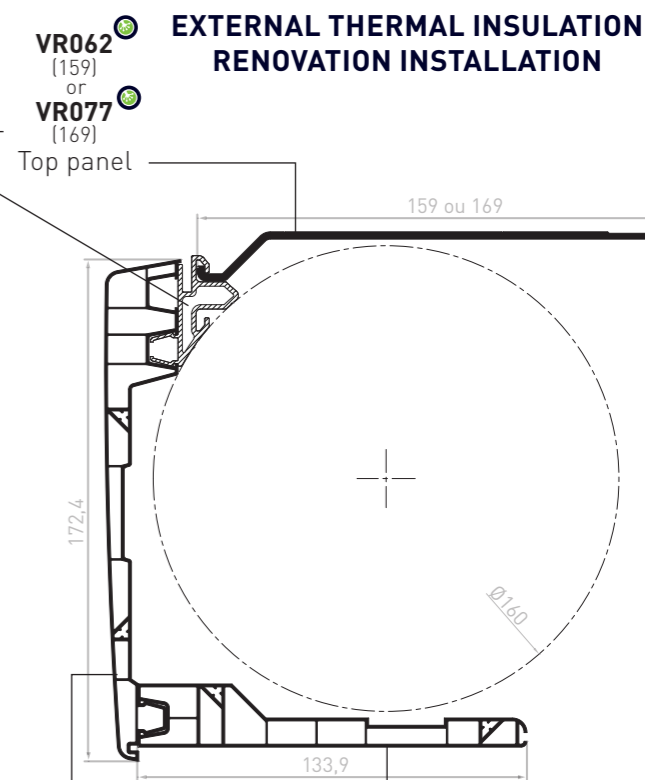

VR031F  
Front plank

VR023  
Bottom panel

### PACK SIZES

	VR023	VR031F	VR062	VR063F	RF019
Bars of 6 ml / pack	4	4	6	2	6
Bars of 6 ml / container	150	108	-	30	-

### COLORS OF THE PLANKS

MASS COLOURED			PLAXED	
White	Beige	Mouse grey	Golden Oak	Grey anthracite

80+ plated film decors available upon request

### END PLATES

**AC047**  
Bearing plate  
25 parts / box

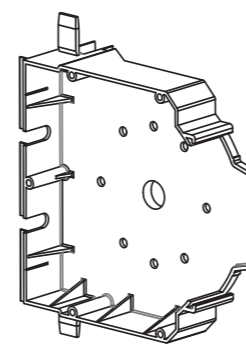

**AC048**  
Motor plate  
25 parts / box

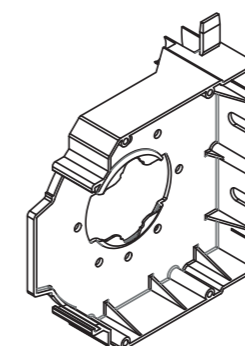

### Colors

Black

### RENOVATION COVER

**AC046**  
Left and right telescopic end plate  
5 pairs / bag

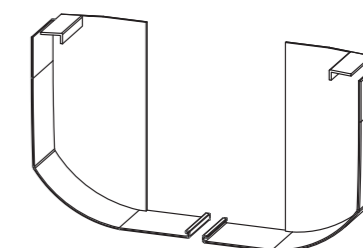

COLORS			PLAXED	
White	Beige	Mouse grey	Golden Oak	Grey anthracite

80+ plated film decors available upon request

### CUSTOMISATION

The exterior panel VR063 is available as mass coloured (white, beige, grey and anthracite grey) and with a PVC or aluminium filming.

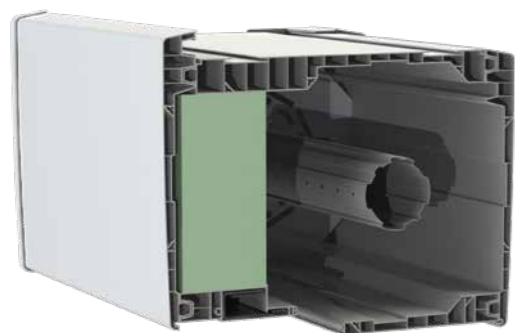

# GVR.e

## EXTERNAL WINDING BOX

Ideal in new-generation buildings with exterior thermal insulation.

### A TECHNICAL RESPONSE

This box adapts to all the joineries of the market: **PVC, ALU and WOOD**. Its roll-up diameter is 186 mm and its access is easy thanks to the interior trapdoor for the first floor.

All types of maneuvers are possible with the exit of the winch on the front or on the underside. The box comes with a screen kit, a set of PVC and ALU guides.



### INSTALLATIONS

### SOLAR PROTECTION

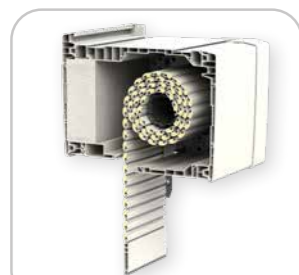

GVR.e  
Lame Bioclimatique®

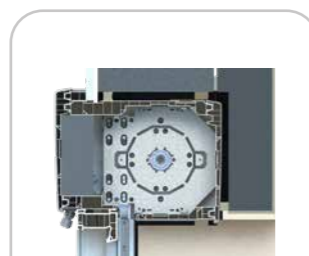

Installation as  
external thermal  
insulation.

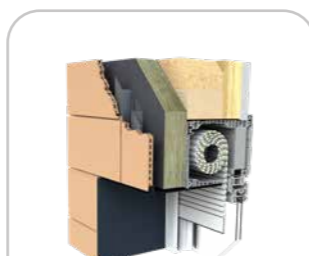

Installation on  
timber-frame house

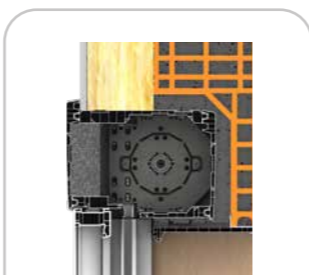

Half-lintel  
installation  
(1<sup>st</sup> floor access  
through  
interior hatch)

The GVR.e is used exclusively for an assembly with a recess between the internal wall of the box and the plane passing through the interior side of the fixed frame or opening casement.

### CERTIFIED PERFORMANCE

**THERMAL** :  $U_c = 0.54 \text{ W/m}^2.K.$

**ACOUSTIC** :  $D_{n,e,w} + C_{tr}$  up to 50 dB (FCBA report)

**AIR FLOW** :  $C^*4$  for all installations (new/reno) and operations on the market (strap, winch, motor) - (AT value)

**WIND** :  $V4^*$  with opening width up to 3 m (AT value)

## PLANKS - GVR.E 205

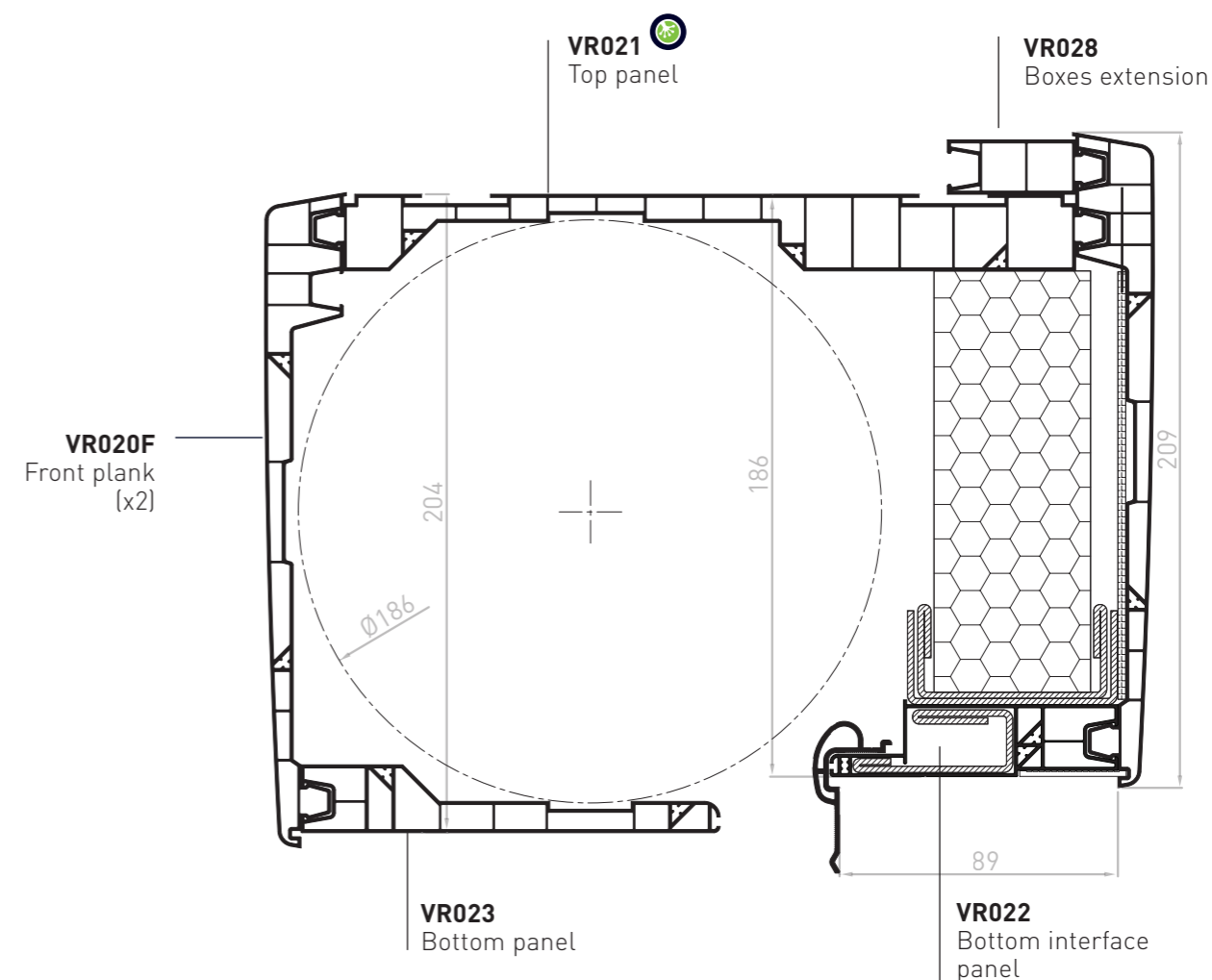

### PACK SIZES

	VR020F	VR021	VR022	VR023	VR028
Bars of 6 ml / pack	4	4	4	4	10
Bars of 6 ml / container	72	70	160	150	-

### COLORS OF THE PLANKS MASS COLOURED



### PLAXED

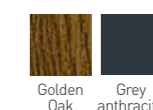

80+ plated film decors  
available upon request

### PANEL KIT

**VRKE2**  
5 planks kit  
[2 x VR020F]+VR021+VR022+VR023  
1 kit / pack  
18 kits / container

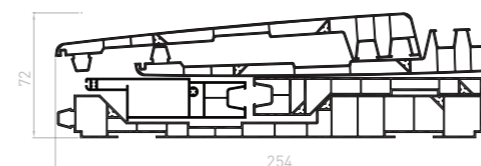

**VRKE1**  
4 planks kit  
VR020F+VR021+VR022+VR023F  
1 kit / pack  
18 kits / container

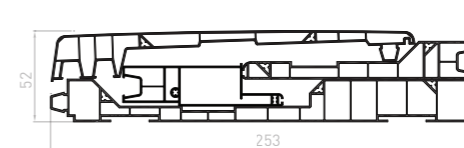

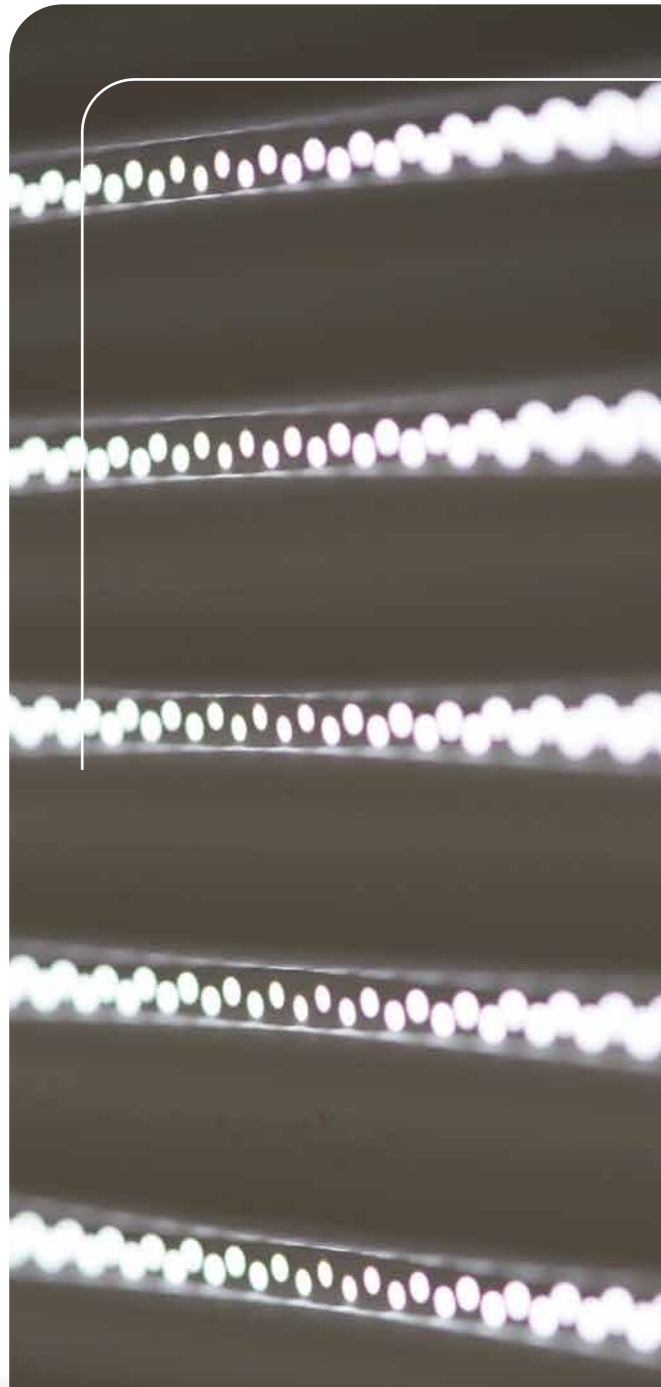

Lame Bioclimatique®  
TRADEMARK & DESIGN REGISTERED

*A Geplast Building innovation*

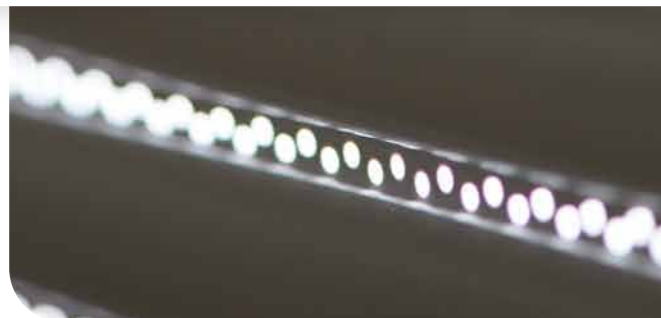

ALUMINIUM



## ITS STRENGTHS

### ◆ Solar gain management

Control of solar gain with **4 times more light and ventilation** in the home than a standard slat for optimal comfort in summer.

Exceptional visibility toward outside in the open position.

Regular micro-punching diffusing a soft and soothing light within the living rooms.

### ◆ New functionalities

Safety functions and total opacity in the closed position for optimum sleeping comfort thanks to the development of our rubber seals integrated into our sliders.

Improved acoustic comfort when raising / lowering the apron.

Integrated insect screen and blind functions.

### ◆ Easy to implement

Manufacture and installation identical to a standard slat.

**Ideal for large widths bay.**

## REGISTERED TRADEMARK AND MODEL



The shape and aesthetics of Lame Bioclimatique® are protected at European level by the European Union Intellectual Property Office (EUIPO).



Lame Bioclimatique® is a trademark of Geplast Building and is registered with the Institut National de la Propriété Industrielle (INPI).

## AVAILABLE COLOURS

### Lame Bioclimatique® & final slat

Please contact us to discover the other colors.

#### ALUMINIUM LAQUERED COLOURS

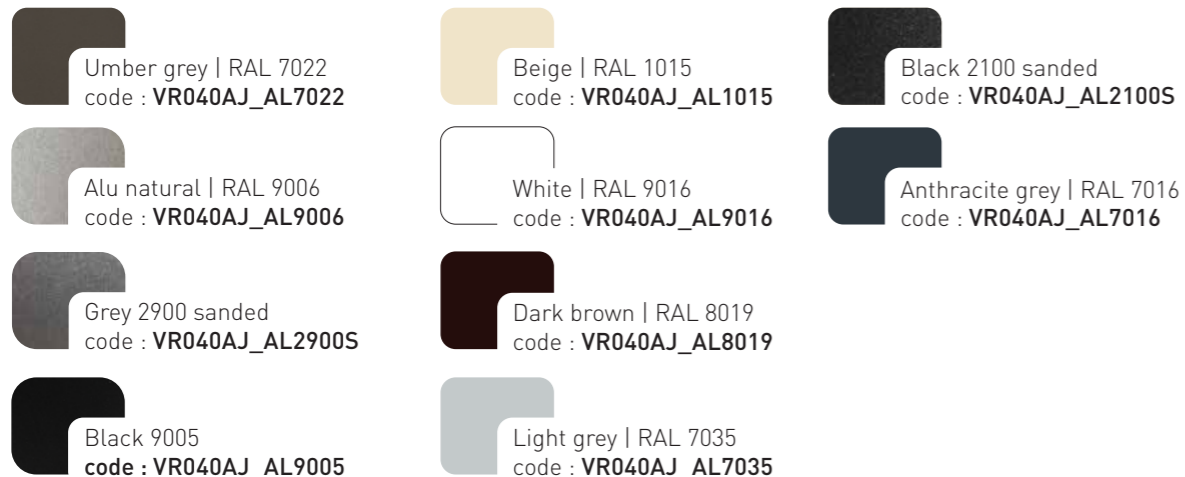

## PERFORMANCES

### ALUMINIUM THERMAL

Rsh = 0,01 m<sup>2</sup>.K/W  
Classe 4 : ΔR = 0,15 m<sup>2</sup>.K/W  
Classe 5 : ΔR = 0,18 m<sup>2</sup>.K/W



Width Height	0 to 2000	2100	2200	2300 to 2400	2500	2600 to 2800	2900	3000
2250 mm	V*6	V*5	V*5	V*5	V*4	V*4	V*3	V*3
1400 mm	V*6	V*6	V*6	V*5	V*5	V*4	V*4	V*4

### LIGHT TRANSMISSION



Normal / hemispheric light transmission factor :  
 $T_v^{nh} = 3\%$  (PV CSTB)

The bioclimatic slat, in the openwork position, is comparable to a awning fabric or ZIP blind in terms of light comfort and provides excellent glare control.

Solar radiation transmittance inside the building, roller shutter closed		
Light colours (white, light grey...)	[L* >82]	Sws = 0,05
Dark colours (brown, black, ...)	[L* ≤82]	Sws = 0,10

### AIR PERMEABILITY



The bioclimatic slat allows an airflow (over-ventilation that allows the air in the house to be cooled):

$Q_a = 939\text{m}^3/\text{h}$  per m<sup>2</sup> of deck (PV CSTB)

### CORROSION RESISTANT

New, more corrosion-resistant aluminium strip.  
Salt spray test (PV CSTB).

## REFERENCES AND PACK SIZE

■ The apron must be tested vertically upwards and downwards before being installed on the customer's premises.

### Lame Bioclimatique®

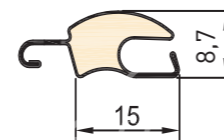

**NEW**

**New 0.30mm strip, achieved with 99.5% recycled aluminium & more resistant to corrosion.**  
**New high density foam 115Kg/m<sup>3</sup> for exceptional rigidity**

Nominal thickness	8,7 mm
Working height	15 mm
Number of slats / m	67
Weight	5 Kg/m <sup>2</sup>
Max width	3 m
Max surface area	7 m <sup>2</sup>
Standard length	6 m

### VR040AJ\_AL

Bioclimatic slat ALU openwork roller shutter 15 x 8,7mm  
65 bars of 6 ml / pack or 5 trays of 13 slides

### Final slat

#### VR081F\_AL

Final slat 49 x 8,5 mm  
10 bars of 6 ml / pack



#### LACQUERED COLORS IN STOCK



Gloss white 9016



Satin anthracite 7016



Gloss

+ other colours available, similar to those of Bioclimatic slat from 60ml upwards



#### AC120\_NO004

Final slat seal  
200mm roll

#### COLOR



Black

## Installation



FoKus 235 box  
Timber frame assembly  
ALU bioclimatic slat  
anthracite grey 7016

#### WINDING DIAMETERS IN BOXES

	Maximum number of slats	Maximum height under box	Maximum winding Ø
IrYs	164	2450	Ø 200
FoKus 235	180	2700	Ø 200
FoKus 205	130	1950	Ø 180
FoKus 168	90	1350	Ø 145
GVR.e	150	2250	Ø 185
GVR.dL	150	2250	Ø 185
Reno City	100	1500	Ø 170
GVR.r	103	1550	Ø 160

The heights under the box are given as an indication and must be verified by tests in situ at the assembler's.

## Rails and rubber seals

**It is imperative to use the PVC/ALU guides, rubber seals and end slats, without which GEPLAST declines all responsibility.**

Designed and extruded in ABS and soft PVC for better resistance to heat and shrinkage, our rubber seals can be integrated with Geplast's PVC or ALU guiderails as well as with traditional and renovation guiderails on the market.

With Geplast aluminium guide :

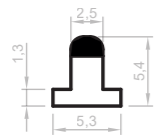

**AC101\_N0004**  
Black rubber seals  
5,3 x 5,4 mm  
50 bars of 6 ml / pack

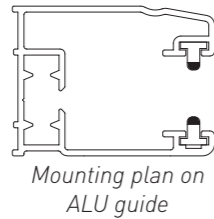

Mounting plan  
on  
ALU guide

With Geplast PVC guide :

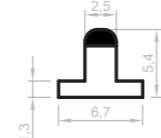

**AC102\_N0004**  
Black rubber seals  
6,7 x 5,4 mm  
50 bars of 6 ml / pack

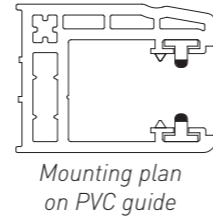

Mounting plan  
on  
PVC guide

With traditional aluminium guiderails and market renovations :

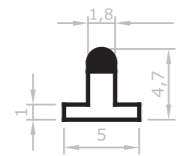

**AC191\_N0004**  
Black rubber seals  
5 x 4,7 mm  
50 bars of 6 ml / pack

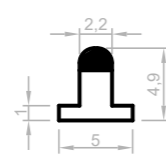

**AC100\_N0004**  
Black rubber seals  
5 x 4,9 mm  
50 bars of 6 ml / pack

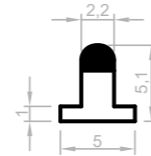

**AC103\_N0004**  
Black rubber seals  
5 x 5,1 mm  
50 bars of 6 ml / pack

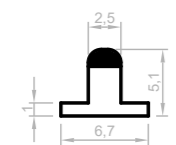

**AC117\_N0004**  
Black rubber seals  
6,7 x 5,1 mm  
50 bars of 6 ml / pack

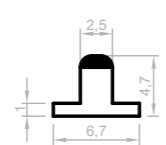

**AC118\_N0004**  
Black rubber seals  
6,7 x 4,7 mm  
50 bars of 6 ml / pack

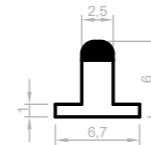

**AC119\_N0004**  
Black rubber seals  
6,7 x 6 mm  
50 bars of 6 ml / pack



Assembly of the  
rubber seal on PVC  
guiderail

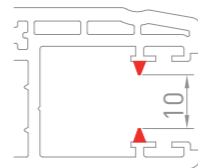

NB : the bioclimatic slat is  
used with the PVC guide and  
the coextruded joint : **JC10**

In accordance with FFB guidelines, roller shutters, when deployed, can sometimes present a wavy appearance. This phenomenon is accentuated for large products. Find out more about the Quality Assessment Guide for roller shutters, available and downloadable from the websites : [www.geplast.fr](http://www.geplast.fr) and [www.groupe-actibaie.org](http://www.groupe-actibaie.org).

## SPECIFIC MACHINES

Geplast has set up a partnership with manufacturers of machines and roller shutter end caps. These end caps, to be placed at the edges of the slats, offer many advantages :

- ◆ Reduced manufacturing time
- ◆ Easier to roll up the apron
- ◆ Keeping the slats in place against translation
- ◆ Anti-noise and anti-friction clamping system



Machine for cutting and assembling  
aluminium roller shutter apron



Manual stapler

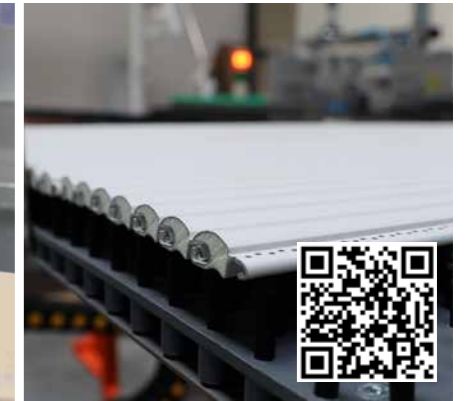

Automatic stapler



### END CAP FOR 15 MM BIOCLIMATIC SLAT



**AC079**  
10 000 pieces/box

The end cap is attached to the left and right ends of the aluminium slats. Its role is to stop the horizontal translation of the slats in order to guarantee an optimal operation of the bioclimatic roller shutter.



### ALUMINIUM SLAT FORMING MACHINE

"This integration has enabled us to acquire new technical skills in-house and to fully control the production of our bioclimatic slat.

Made from 99.5% recycled aluminium strip, the *Lame Bioclimatique®* is part of a "responsible" approach. It enables us to meet the challenges of the RE2020, which now requires the control of ventilation and solar gain within homes".

Maxime Grimault  
Sales & Marketing Director

## COMPARISON ROLLER SHUTTER SLATS

VIDEO  
Lame bioclimatique®

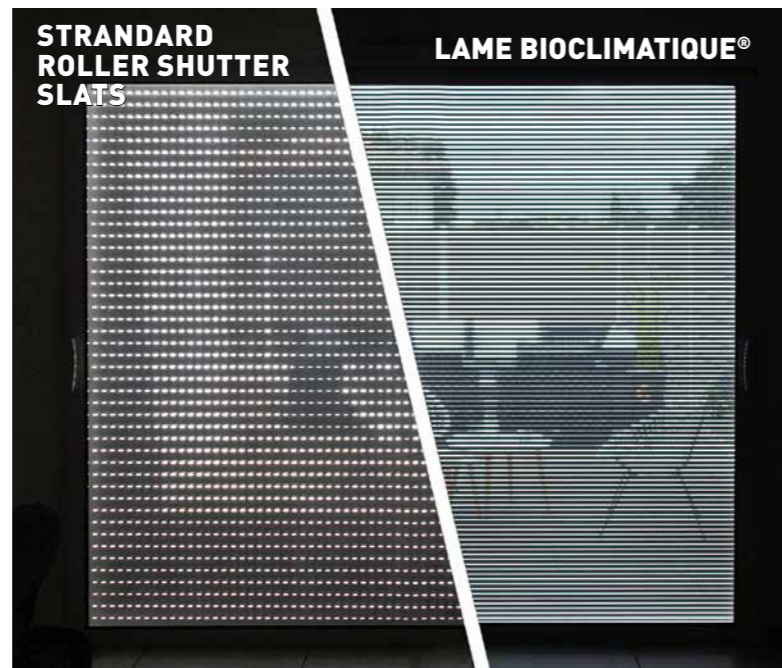

# Lame Bioclimatique®

TRADEMARK & DESIGN REGISTRATED



"Classic" blade  
43 mm

0.8 x 12mm openings  
312mm<sup>2</sup> for 1m of slats  
22 openwork slats for 1m height  
=  
6,900mm<sup>2</sup> for 1m<sup>2</sup>,  
**0.7 % of openings**



Lame Bioclimatique®  
15 mm

Holes 1.5mm diameter  
588mm<sup>2</sup> for 1m of slats  
52 openwork slats for 1m height  
=  
30 600mm<sup>2</sup> for 1m<sup>2</sup>,  
**3% openings**

$$3/0,7 = 4,3$$

**Bioclimatique slat therefore has 4x more light  
and air than a "conventional" blade.**

Normal/hemispherical light transmission  
factor hemispherical:  $T_{vnh} = 3\%$  (PV CSTB)

# Guides

## > PVC GUIDES - THICKNESS 2,5 MM

By default, all our veneered PVC guides are delivered with a 12 mm passage (11 mm slat).

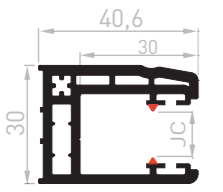
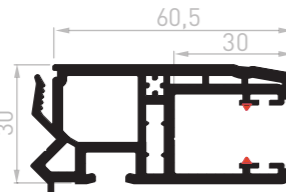
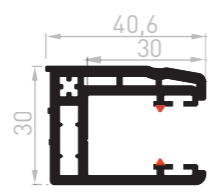
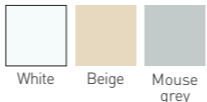
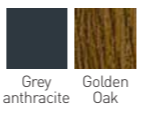
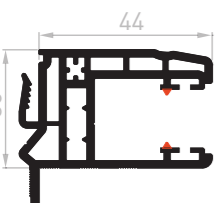
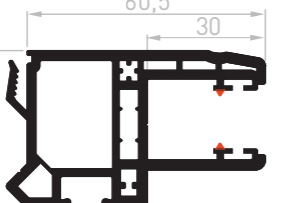
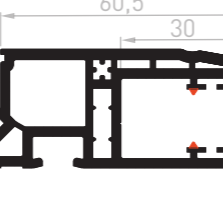
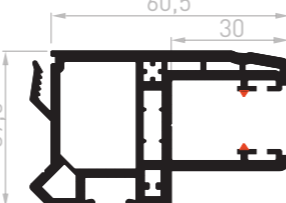
<p><b>VR003F</b> Single guide 30 mm at 90° 6 bars of 6 ml / pack 320 bars of 6 ml / container</p> 	<p><b>VR004F</b> <small>PROFILS DE FENÊTRES EN PVC</small> Tapped renovation guide 30 mm with spoiler 4 bars of 6 ml / pack 144 bars of 6 ml / container</p> 	<p><b>VR005F</b> Single guide 30 mm at 93° 6 bars of 6 ml / pack 300 bars of 6 ml / container</p> 	<p><b>COLORS</b> <b>MASS COLOURED</b></p>  <p><b>PLAXED</b></p>  <p>80+ plated film decors available upon request</p>
<p><b>VR007F</b> Renovation guide 30 mm with spoiler 4 bars of 6 ml / pack 221 bars of 6 ml / container</p> 	<p><b>VR008F</b> <small>PROFILS DE FENÊTRES EN PVC</small> Tapped renovation guide 40 mm with spoiler 4 bars of 6 ml / pack 120 bars de 6 ml / container</p> 	<p><b>VR014F</b> <small>PROFILS DE FENÊTRES EN PVC</small> Tapped renovation guide 30 mm 4 bars of 6 ml / pack 144 bars of 6 ml / container</p> 	<p><b>VR018F</b> <small>PROFILS DE FENÊTRES EN PVC</small> Tapped renovation guide 40 mm 4 bars of 6 ml / pack 120 bars of 6 ml / container</p> 

## > PVC GUIDES - THICKNESS 1.2 MM

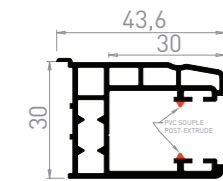
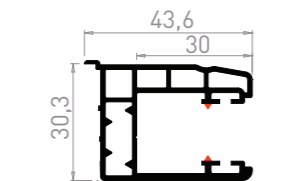
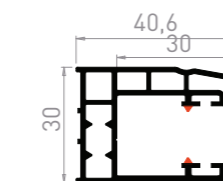
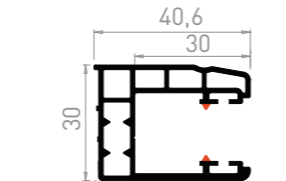
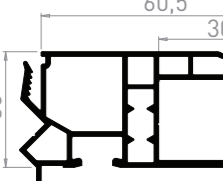
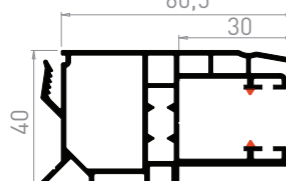
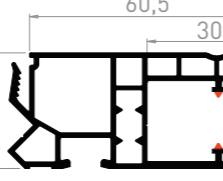
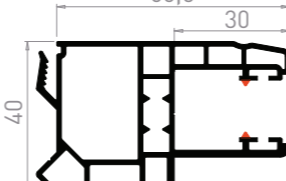
<p><b>VR013JC</b> Single guide 30 mm at 90° with spoiler 6 bars of 6 ml / pack 300 bars of 6 ml / container</p> 	<p><b>VR015JC</b> Single guide 30 mm at 93° with spoiler 6 bars of 6 ml / pack 300 bars of 6 ml / container</p> 	<p><b>VR033JC</b> Single guide 30 mm at 90° 6 bars of 6 ml / pack 320 bars of 6 ml / container</p> 	<p><b>VR035JC</b> Single guide 30 mm at 93° 6 bars of 6 ml / pack 300 bars of 6 ml / container</p> 
<p><b>VR036JC</b> Tapped renovation guide 30 mm with spoiler 4 bars of 6 ml / pack 144 bars of 6 ml / container</p> 	<p><b>VR038JC</b> Tapped renovation guide 40 mm with spoiler 4 bars of 6 ml / pack 120 bars of 6 ml / container</p> 	<p><b>VR046JC</b> Tapped renovation guide 30 mm 4 bars of 6 ml / pack 144 bars of 6 ml / container</p> 	<p><b>VR048JC</b> Tapped renovation guide 40 mm 4 bars of 6 ml / pack 120 bars of 6 ml / container</p> 



**COLORS**  
**MASS COLOURED**



White

## > ALU GUIDES

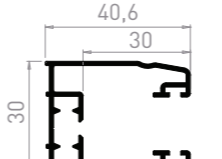
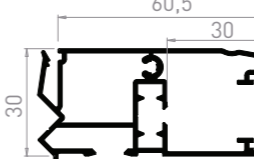
 **LACQUERED / RAW - DELIVERED WITHOUT BRUSH SEALS**

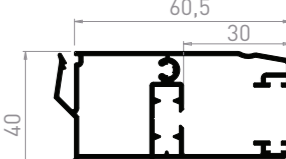
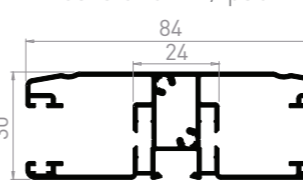
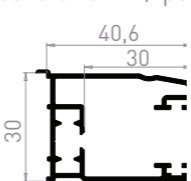
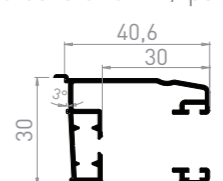
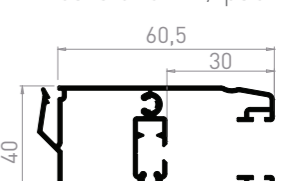
<p><b>VR003_AL</b> Single guide 30 mm at 90° 6 bars of 6 ml / pack</p> 	<p><b>VR004_AL</b> Tapped renovation guide 30 mm with spoiler 4 bars of 6 ml / pack</p> 	<p><b>VR005_AL</b> Single guide 30 mm à 93° 6 bars of 6 ml / pack</p> 	<p><b>VR008_AL</b> Tapped renovation guide 40 mm with spoiler 4 bars of 6 ml / pack</p> 
<p><b>VR010_AL</b> Double guide 30 mm 4 bars of 6 ml / pack</p> 	<p><b>VR013_AL</b> Single guide 30 mm at 90° with spoiler 6 bars of 6 ml / pack</p> 	<p><b>VR015_AL</b> Single guide 30 mm at 93° with spoiler 6 bars of 6 ml / pack</p> 	<p><b>VR018_AL</b> Tapped renovation guide 40 mm 4 bars of 6 ml / pack</p> 

## SEALING PLATES

**AC002**  
For VR004, VR014 and VR007  
Rolls 200 pairs / pack

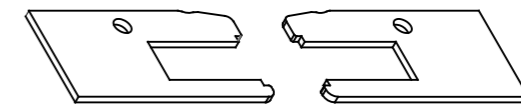

**AC008**  
For VR008 and VR018  
Rolls 200 pairs / pack

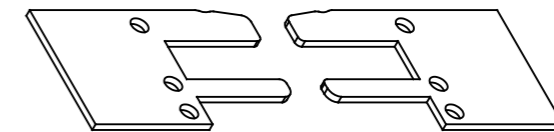

**AC007**  
For VR008 and VR018, VR009 and VR019  
Rolls 200 pairs / pack

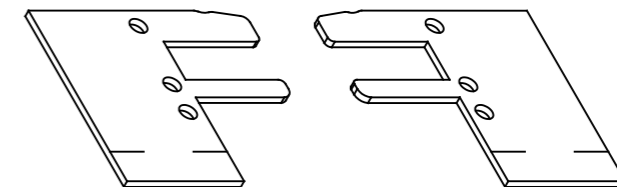

**COLORS**



White Black

## BLOCKS FOR GUIDES

**VR009**  PROFILS DE FENÊTRES EN PVC

10 mm spacer

10 bars of 6 ml / pack

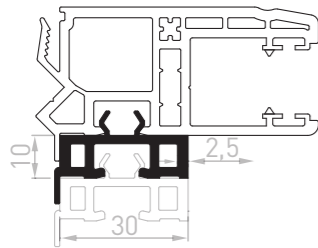

**VR019**  PROFILS DE FENÊTRES EN PVC

Edged 10 mm spacer for VR004 / VR006

10 bars of 6 ml / pack

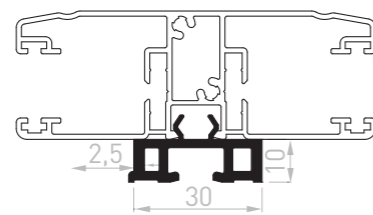

**VR012**

40 mm connecting profile for double guide

10 bars of 6 ml / pack

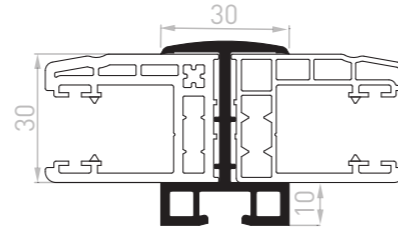

**VR065**  PROFILS DE FENÊTRES EN PVC

17 mm spacer for tapped renovation guide

6 bars of 6 ml / pack

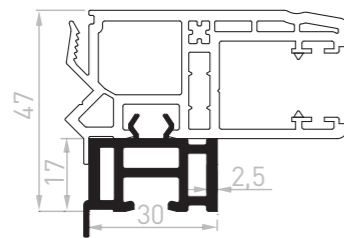

**VR065D**  PROFILS DE FENÊTRES EN PVC

Edged 17 mm spacer for tapped renovation guide

6 bars of 6 ml / pack

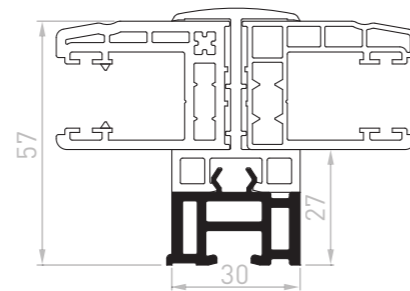

## Practical guide

### SCREWING

To screw **the guides** to your frame, we recommend two SFS screws :

**SFS Screw :**  
SPK/5-74/GS - 4x10

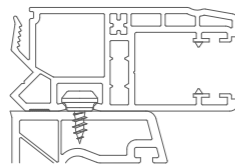

**SFS screw :**  
SPT/24 - 4,3x30 GS

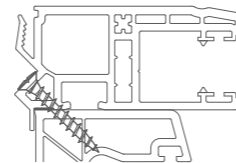

**The blocks** are all to be fixed with an SFS reference stud screw : SPK/5-74/GS - 4x10

## CONFIGURATIONS

Our range of blocks makes it easier to use the key for renovation doors with lock. It prevents the plank from rubbing on the sliding PVC casements. The VR065 filler plate includes the 120 mm guide when combined with a 40 mm tapped guide (ideal for coated joinery).

The blocks offset the panel of the joinery in the following cases :

### ASSEMBLY ON TAPPED GUIDE

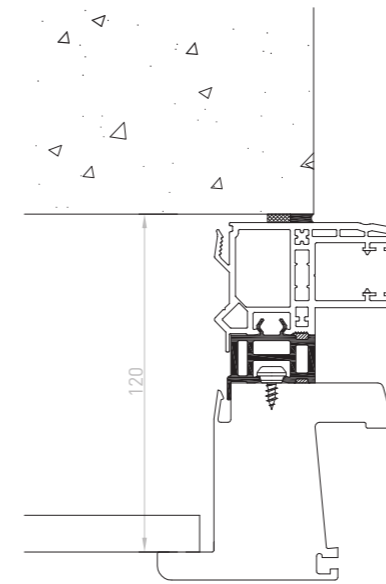

### ASSEMBLY ON SLIDING GUIDE

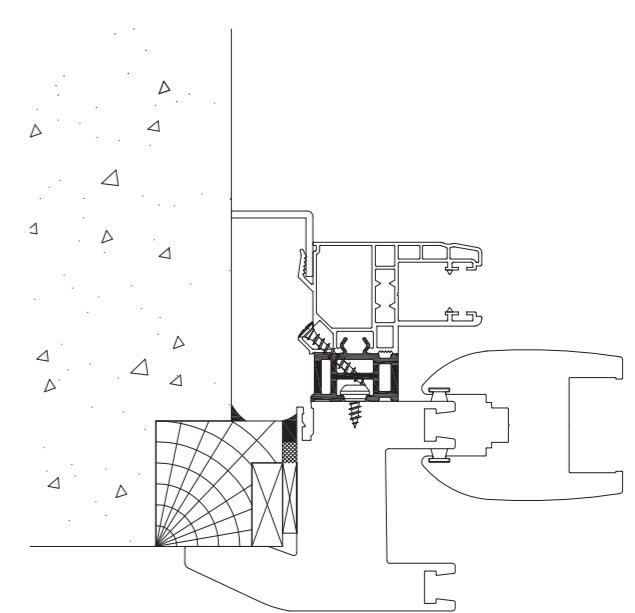

### ASSEMBLY ON DOUBLE GUIDE

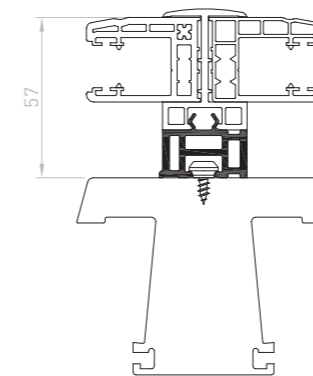

### ASSEMBLY ON LOCK HOLDER

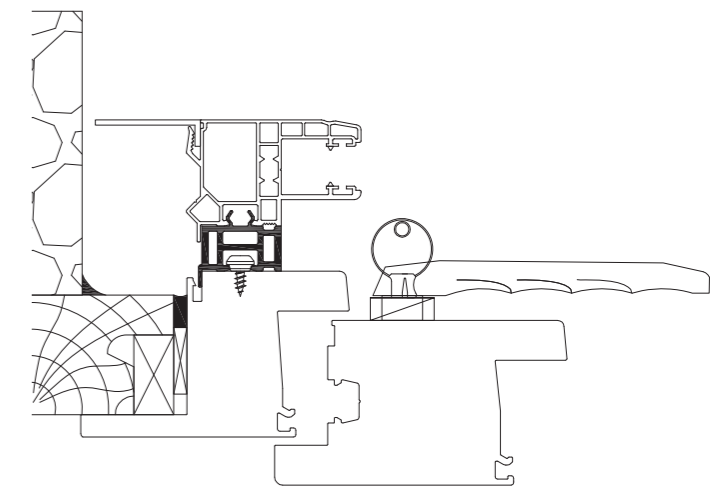

To obtain all the technical documents, including all the installation configurations, please contact our customer service department : [commercial@geplast.fr](mailto:commercial@geplast.fr)

**NEW**  
**Oktego® range**   
*Innovation for octagonal tubes*

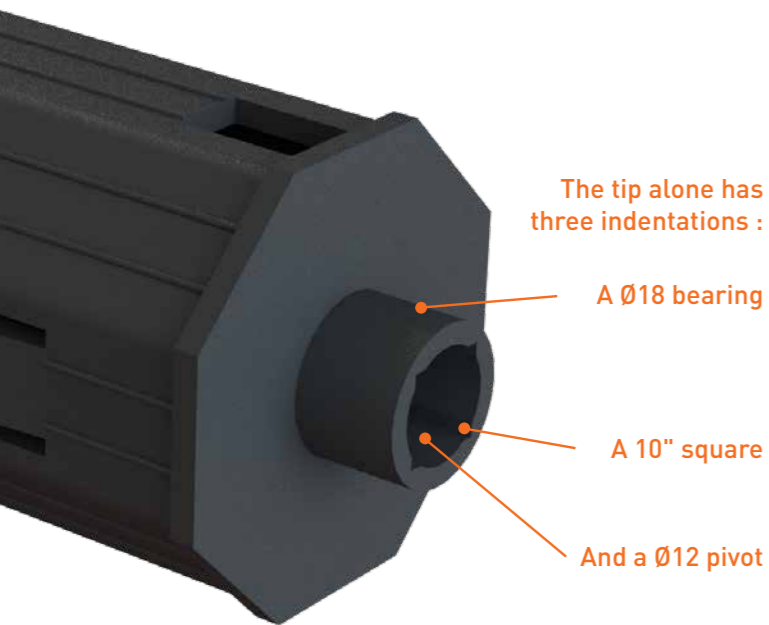

**A TECHNICAL SOLUTION**

Discover our range of accessories specially designed for octagonal tubes, combining innovation, practicality and environmental commitment.

**Versatility and simplicity:** A small number of parts for a wide range of uses, optimising assembly and modularity.

**Suitable for the French and European markets:** Designed to meet quality and safety requirements.

**Easy maintenance and after-sales service:** Thanks to the telescopic end cap, our accessories ensure quick and efficient maintenance.

**Intuitive installation:** Automatic clipping of square accessories for simplified and effortless attachment.

**Optimised compatibility:** Our accessories are perfectly suited to 60 octagonal tubes. Each part is made from 70% to 98% recycled materials sourced from post-industrial waste.

**SUITABLE FOR ALL TYPES OF ROLLER SHUTTER BOX**

**RENOVATION BOX**



**INTERIOR WINDOW BOX AND HALF LINTEL**



**TRADITIONAL BOX**



**END CAPS**



**AC180**   
 Octagonal tube end cap 60  
 100 pieces / Pkg



**AC181**   
 Octagonal tube end cap 52  
 100 pieces / Pkg



**AC182**   
 Octagonal tube end cap 40  
 100 pieces / Pkg

The octagonal tube end piece can be retracted into the octagonal tube to facilitate after-sales service.

**SQUARES & FORK**



**AC186**   
 Fluted mouthpiece  
 50 pieces / bag

The claw square allows the Oktego end cap to be mounted in a renovation box thanks to the Ø12 hole, with claw-type winch operation.



**AC187**   
 Square pin Ø10  
 250 pieces / bag

The pin squares are available in Ø10 and Ø12 and can be adapted to boxes with ball bearing mountings.



**AC188**   
 Square pin Ø12  
 250 pieces / bag



**AC189**   
 Clip-on Square  
 250 pieces / bag

The clip-on square allows the end cap to be fixed onto metal drawers or consoles, thanks to the fork that is easy to install and remove, making after-sales service easier.



**AC190**   
 Fork  
 100 pieces / Pkg



## JOINERY

- 42 Renovation joinery installations
- 42 Complete removal solution
- 45 Profiles for classic renovation :
  - 45 > Flaps
  - 48 > Corner angles
  - 50 > Flat sections
  - 51 > Panels
  - 52 > Tapped inserts
  - 56 > Tapped
  - 56 > Glazing bars
  - 57 > Drainage channels
  - 57 > Connecting profiles and joint cover
  - 58 > Trim mouldings
  - 59 > Miscellaneous blocks and profiles
  - 61 > Storage posts

# Renovation joinery installations



## REMOVING EXISTING FRAMES

The old joinery is removed with its frame. A new window or door is fitted with a frame to ensure a thermal seal between the joinery and the brickwork.



## KEEPING EXISTING FRAMES

This type of installation implies the absolute need to maintain suitable ventilation between the old frame and the exterior trim so as not to jeopardise its durability.

# Complete removal solution

## ADVANTAGES OF COMPLETE REMOVAL

- Maximum daylight,
- Perfect seal,
- Practically identical appearance to installation in a new construction.

## ADVANTAGES OF THE GEPLAST SOLUTION

- Can be adapted to all types of installation on the market thanks to their different widths
- Clip directly into the groove of the double-groove frame and align perfectly with the face of the frame
- The groove on the underside can accommodate compensating shims.
- Thermal improvement during installation by integrating insulation right up to the joinery,
- Installation complies with DTU 36-5.



view from above

## NEW TRIM MOULDINGS

### Assembly drawing

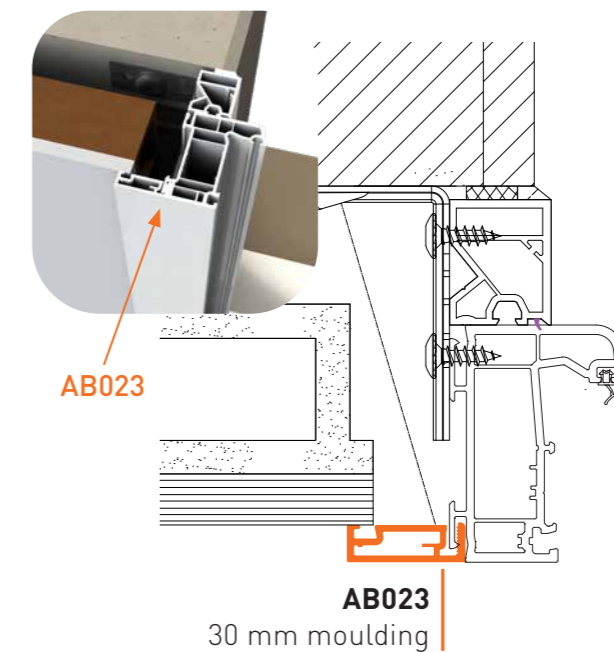
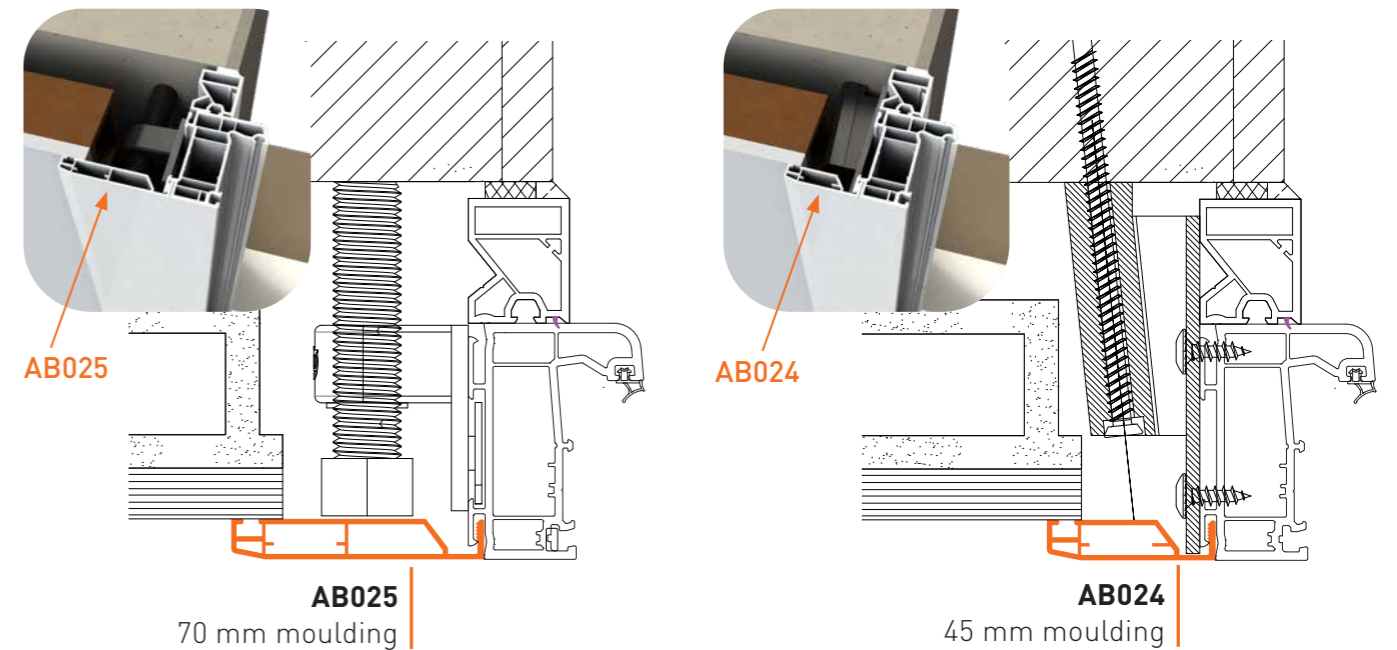

### Examples of assemblies with different types of fixings

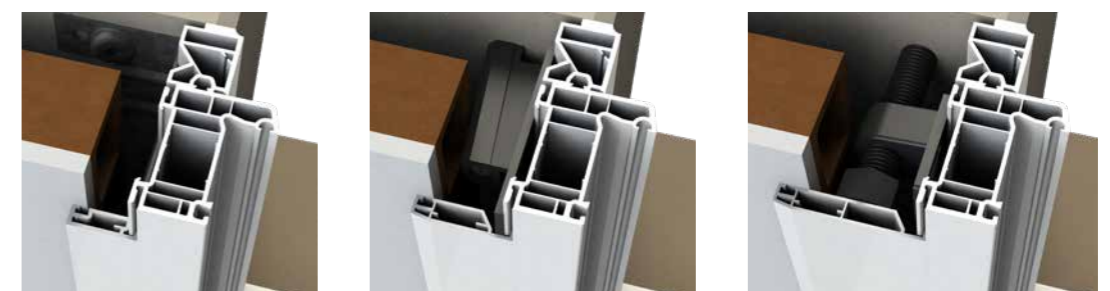

## MOULDING

### COLORS MASS COLOURED

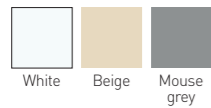

### PLAXED

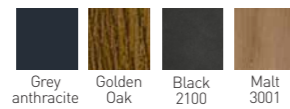

80+ plated film decors available upon request

**AB023**  
30 mm moulding  
10 bars of 6 ml / pack  
570 bars of 6 ml / container

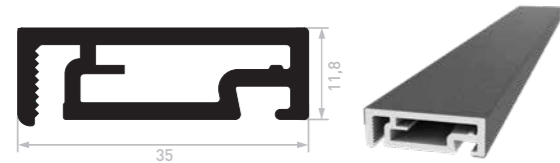

**AB024**  
45 mm moulding  
10 bars of 6 ml / pack  
546 bars of 6 ml / container

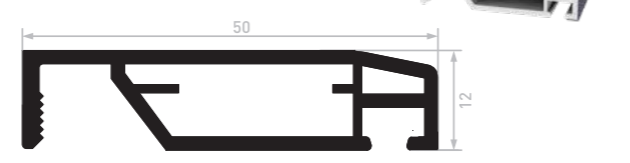

**AB025**  
70 mm moulding  
10 bars of 6 ml / pack  
336 bars of 6 ml / container



## ANGLE COVER

### COLORS MASS COLOURED



**PIM013D**  
Angle cover for AB025  
100 parts / bag



**PIM015**  
Angle cover for AB024  
200 parts / bag



**PIM016**  
Angle cover for AB023  
200 parts / bag



## Profiles for classic renovation

This list is not exhaustive. For a complete overview of our flanges, angle bars and flat bars, please contact our customer service department: [commercial@geplast.fr](mailto:commercial@geplast.fr).

Upon request, a protective film can be applied to flanges, angle bars and flat bars.

## ALU FLAP - THICKNESS 2.5 MM

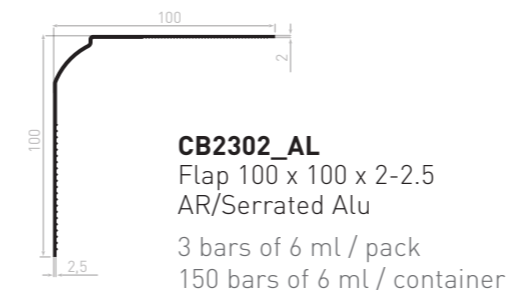

### LACQUERED COLOR



### PLAXED

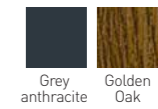

80+ plated film decors available on request

## 2.4 MM FLAPS SERRATED AND PLAXED

Colors plaxed

**CB2401CF\_AL**  
ALU flap 100x100x2.4 /Serrated, film coated  
3 bars of 6 ml /pack  
also available to order by the bar.

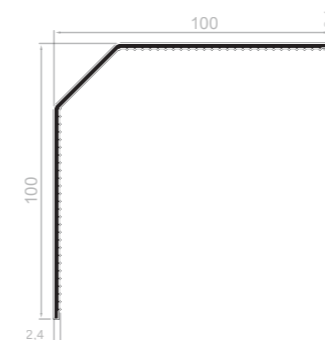

Colors mass coloured

**\*CB2401C**  
Flap 100x100x2.4 /Serrated  
5 bars of 6 ml /pack  
mass coloured  
200 bars of 6 ml / container

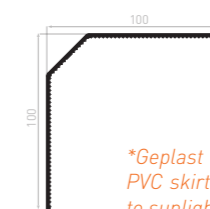

\*Geplast declines all responsibility for this plaxed PVC skirting board in the event of deformation due to sunlight.

### COLORS PLAXED



90+ plated film decors available on request

### COLORS MASS COLOURED

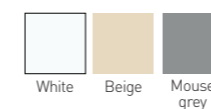

## > PVC FLAP – THICKNESS 2.5 MM

**CB2501**  
 Flap 100 x 100 x 2.5/45°  
 DR  
 5 bars of 6 ml / pack  
 250 bars of 6 ml / container

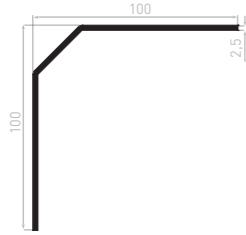

**CB2501CS**  
 Flap 100 x 100 x 2.5/45°  
 DR/Serrated breakable  
 10 bars of 6 ml / pack  
 250 bars of 6 ml / container

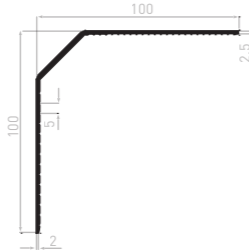

### COLORS MASS COLOURED

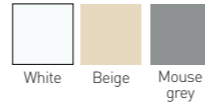

**CB2502CS**  
 Flap 100 x 100 x 2.5/45°  
 AR/Serrated breakable  
 5 bars of 6 ml / pack  
 250 bars of 6 ml / container

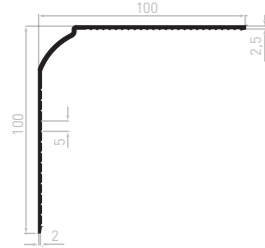

**CB2512**  
 Flap 100 x 100 x 2.5/45°  
 AR  
 5 bars of 6 ml / pack  
 250 bars of 6 ml / container

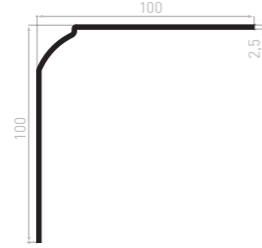

**CB2504**  
 Flap 110 x 100 x 2.5  
 AR-2 Walls  
 5 bars of 6 ml / pack  
 170 bars of 6 ml / container

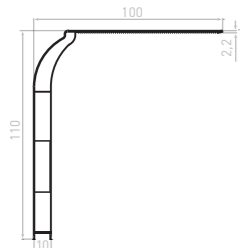

**CB2511**  
 Flap 100 x 100 x 2.5/45°  
 AR/Serrated  
 5 bars of 6 ml / pack  
 250 bars of 6 ml / container

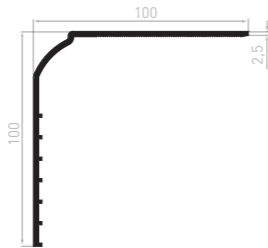

### COLORS MASS COLOURED



### PLAXED

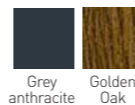

80+ plated film decors  
 available upon request

## > PVC FLAP – THICKNESS 2.7 MM

### COLORS MASS COLOURED

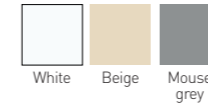

**CB2701**  
 Flap 100 x 100 x 2.7/45°  
 DR  
 5 bars of 6 ml / pack  
 200 bars of 6 ml / container

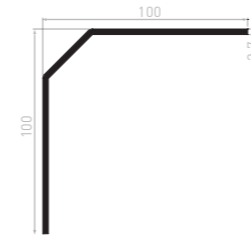

**CB2701C**  
 Flap 100 x 100 x 2.7/45°  
 DR/Serrated  
 5 bars of 6 ml / pack  
 250 bars of 6 ml / container

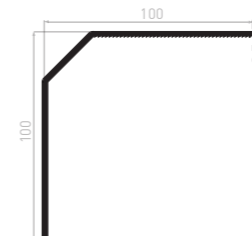

**CB2701CS**  
 Flap 100 x 100 x 2.7/45°  
 DR/Serrated breakable  
 5 bars of 6 ml / pack  
 250 bars of 6 ml / container

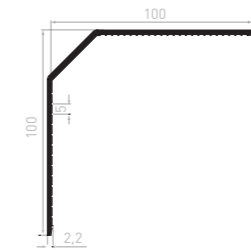

**CB2702**  
 Flap 100 x 100 x 2.7/45°  
 AR  
 5 bars of 6 ml / pack  
 250 bars of 6 ml / container

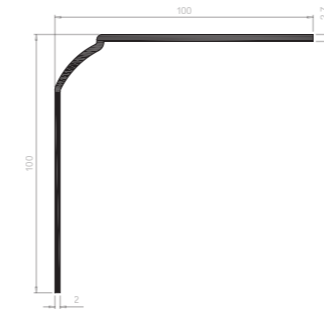

**CB2702CS**  
 Flap 100 x 100 x 2.7/45°  
 DR/Serrated breakable  
 5 bars of 6 ml / pack  
 250 bars of 6 ml / container

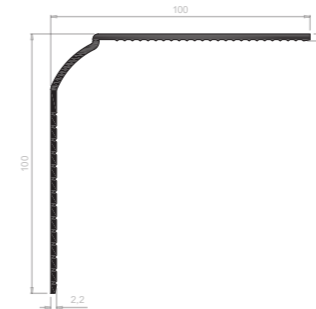

## > PVC FLAP – THICKNESS 3 MM

### COLORS MASS COLOURED

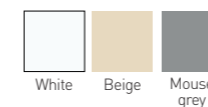

**CB3001**  
 Flap 100 x 100 x 3/45° DR  
 5 bars of 6 ml / pack  
 200 bars of 6 ml / container

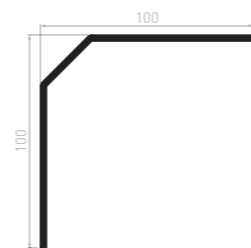

**CB2301**  
 Flap 100 x 100 x 3-2/45° DR  
 5 bars of 6 ml / pack  
 250 bars of 6 ml / container

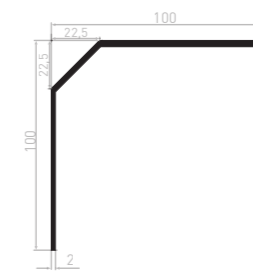

**CB3011**  
 Flap 100 x 100 x 3/45°  
 AR/Serrated  
 5 bars of 6 ml / pack  
 200 bars of 6 ml / container

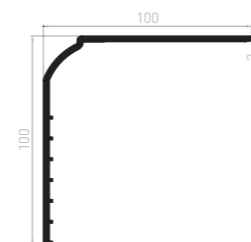

## > ALU CORNER ANGLES - THICKNESS 2,5 MM

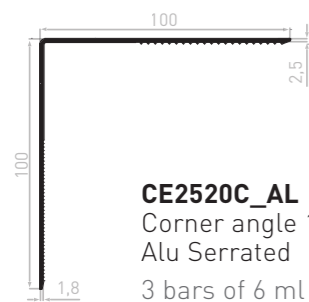

**CE2520C\_AL**  
Corner angle 100 x 100 x 2.5-2  
Alu Serrated  
3 bars of 6 ml / pack

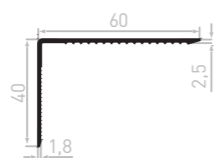

**CE2530C\_AL**  
Corner angle 60 x 40x2.5-2  
Alu Serrated  
5 bars of 6 ml / pack

LACQUERED  
COLOR



PLAXED

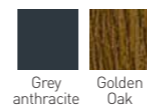

80+ plated film decors  
available upon request

## > CORNER ANGLES - THICKNESS 2.4 MM, PLAXED

**NEW** **CE2419C**  
Corner angle  
160x40x2,4 Serrated  
5bars of 6 ml / pack  
240 bars of 6 ml / container



**NEW** **CE2425C**  
Corner angle 90x30x2,4  
Serrated  
5 bars of 6 ml / pack  
400 bars of 6 ml / container



**NEW** **CE2432C**  
Corner angle  
40x40x2,4 Serrated  
10 bars of 6 ml / pack  
610 bars of 6 ml / container

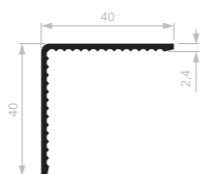

**CE2421C**  
Corner angle 100x60x2,4 Serrated  
5 bars of 6 ml / pack  
350 bars of 6 ml / container  
*also available to order by the bar.*

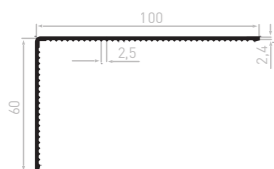

**CE2430C**  
Corner angle 60x40x2,4 Serrated  
5 bars of 6 ml / pack  
500 bars of 6 ml / container  
*also available to order by the bar.*

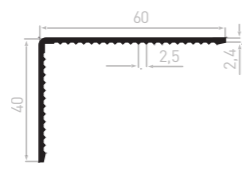

**CE2420C**  
Corner angle 100x100x2,4 Serrated  
5 bars of 6 ml / pack  
250 bars of 6 ml / container  
*also available to order by the bar.*

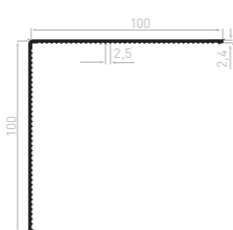

**CE2472C**  
Corner angle 40x20x2,4 Serrated  
20 bars of 6 ml / pack  
600 bars of 6 ml / container  
*also available to order by the bar.*

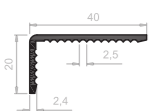

**CE2431C**  
Corner angle 20x20x2,4 Serrated  
5 bars of 6 ml / pack

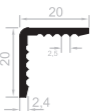

### COLORS PLAXED



80+ plated film decors available on request

### COLORS MASS COLOURED

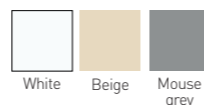

## > PVC CORNER ANGLES - THICKNESS 2 MM



**CE2045**  
Corner angle 60 x 50 x 2  
Breakable  
10 bars of 6 ml / pack  
640 bars of 6 ml / container

COLORS  
MASS COLOURED



**CE2041**  
Corner angle 60x40x2  
15 bars of 6 ml / pack  
600 bars of 6 ml / container

COLORS  
MASS COLOURED



## > PVC CORNER ANGLES - THICKNESS 2.5 MM

COLORS MASS COLOURED

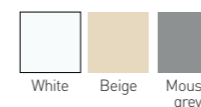

**CE2520C**  
Corner angle 100x100x2,5  
Serrated  
5 bars of 6 ml / pack  
250 bars of 6 ml / container

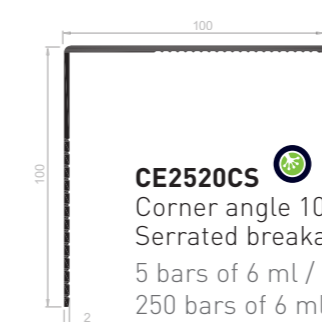

**CE2520CS**  
Corner angle 100x100x2,5-2  
Serrated breakable  
5 bars of 6 ml / pack  
250 bars of 6 ml / container

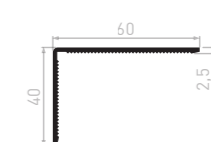

**CE2530C**  
Corner angle 60x40x2,5  
Serrated  
10 bars of 6 ml / pack  
600 bars of 6 ml / container

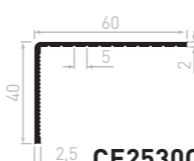

**CE2530CS**  
Corner angle 60x40x2,5-2  
Serrated breakable  
10 bars of 6 ml / pack  
600 bars of 6 ml / container



**CE2535**  
Corner angle  
50x50x2,5  
10 bars of 6 ml / pack  
500 bars of 6 ml / container

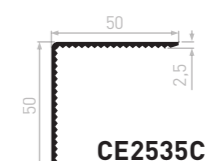

**CE2535C**  
Corner angle 50x50x2,5  
Serrated  
10 bars of 6 ml / pack  
500 bars of 6 ml / container

COLORS MASS COLOURED



PLAXED

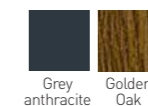

80+ plated film decors  
available upon request



**CE2520**  
Corner angle 100x100x2,5  
5 bars of 6 ml / pack  
250 bars of 6 ml / container

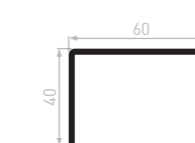

**CE2530**  
Corner angle 60x40x2,5  
10 bars of 6 ml / pack  
500 bars of 6 ml / container



**CE2521**  
Corner angle 100x60x2,5  
5 bars of 6 ml / pack  
300 bars of 6 ml / container

## > PVC ANGLE SECTIONS - THICKNESS 2,7 MM

**NEW CE2715C**  
 Corner angle 123X83X2,7 Serrated Breakable  
 5 bars of 6 ml / pack  
 200 bars of 6 ml / container



**NEW CE2717C**  
 Corner angle 150X100X2,7 Serrated Breakable  
 5 bars of 6 ml / pack  
 150 bars of 6 ml / container

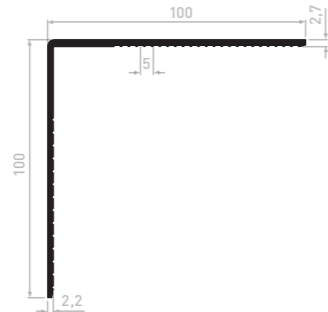

**NEW CE2740C**  
 Corner angle 40X40X2,7 Serrated Breakable  
 10 bars of 6 ml / pack  
 650 bars of 6 ml / container

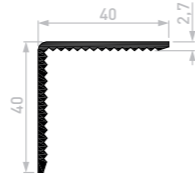

**CE2720CS**  
 Corner angle 100X100X2,7 Serrated Breakable  
 5 bars of 6 ml / pack  
 250 bars of 6 ml / container

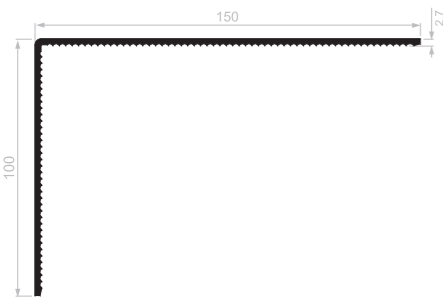

**CE2721C**  
 Corner angle 100X60X2,7 Serrated  
 10 bars of 6 ml / pack  
 350 bars of 6 ml / container

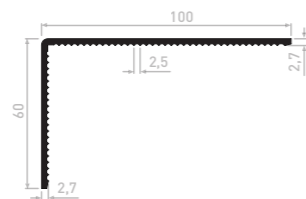

**CE2730C**  
 Corner angle 60x40x2,7 Serrated  
 10 bars of 6 ml / pack  
 500 bars of 6 ml / container

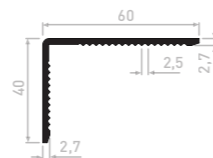

**CE2772C**  
 Corner angle 40x20x2,7 Serrated  
 20 bars of 6 ml / pack  
 700 bars of 6 ml / container

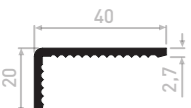

### COLORS MASS COLOURED

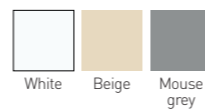

## > PVC ANGLE SECTIONS - THICKNESS 3 MM

**CE3020**  
 Corner angle 100X100X3  
 5 bars of 6 ml / pack  
 200 bars of 6 ml / container

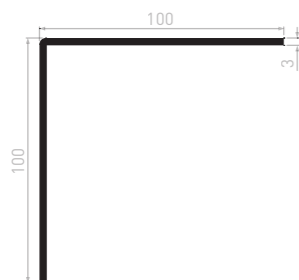

**CE3015**  
 Corner angle 123X83X3  
 5 bars of 6 ml / pack  
 200 bars of 6 ml / container



**CE3030**  
 Corner angle 60X40X3  
 10 bars of 6 ml / pack  
 400 bars of 6 ml / container

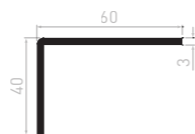

### COLORS MASS COLOURED

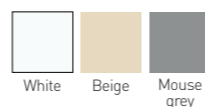

## > FLAT PROFILES THICKNESS 2.5 MM TOOTHED

**PL2505D**  
 Plat 200X2,5 Dentelé  
 5 bars of 6 ml / pack



Also available to order by the bar.

**PL2515D**  
 Flat 100X2,5 Toothed  
 10 bars of 6 ml / pack  
 450 bars of 6 ml / container



Also available to order by the bar.

**PL2545D**  
 Flat 30X2,5 Toothed  
 20 bars of 6 ml / pack  
 1 600 bars of 6 ml / container

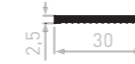

Also available to order by the bar.

**PL2535D**  
 Flat 50X2,5 Toothed  
 20 bars of 6 ml / pack  
 1 000 bars of 6 ml / container



Also available to order by the bar.

### COLORS MASS COLOURED

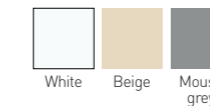

### COLORS PLAXED



80+ plated film decors available on request

## > FLAT PROFILES THICKNESS 2.4 MM SERRATED

**PL2415C**  
 Flat profile 100X2,4 Serrated  
 10 bars of 6 ml / pack  
 600 bars of 6 ml / container



**PL2435C**  
 Flat profile 50X2,4 Serrated  
 20 bars of 6 ml / pack  
 600 bars of 6 ml / container



**PL2445C**  
 Flat profile 30X2,4 Serrated  
 20 bars of 6 ml / pack  
 600 bars of 6 ml / container

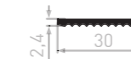

### COLORS MASS COLOURED

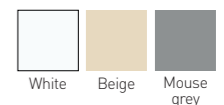

## > FLAT SECTIONS THICKNESS 2 MM DIVISIBLE

**PL2015S**  
 Flat section 100X2 Breakable  
 10 bars of 6 ml / pack  
 400 bars of 6 ml / container



**COLORS**  
**MASS COLOURED**



## > PANEL - THICKNESS 24 MM

**VB001**  
 Triplewall panels 300 x 24  
 60 pitch  
 3 bars of 6 ml / pack  
 42 bars of 6 ml / container



**PANEL COLORS**  
**MASS COLOURED**

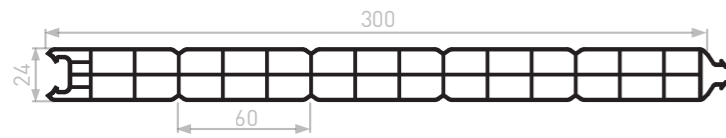
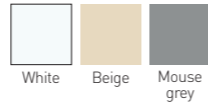

### CERTIFIED

Thermal coefficient : 2.1 W/(m<sup>2</sup>.K)  
 Acoustic coefficient : 26 dB

## > PANEL - THICKNESS 28 MM

**VB008**  
 Triple-cell panel 300 x 28  
 60 pitch  
 3 bars of 6 ml / pack  
 36 bars of 6 ml / container

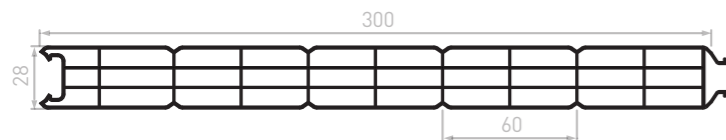

### CERTIFIED

Thermal coefficient: 1.647 W/(m<sup>2</sup>.K)

## > TAPPED INSERTS

The entire tapées programme is certified by CSTB QB59.



### NEW - PRE-PUNCHED TAPPED FURS



The tapped furs are now pre-drilled with Ø4 mm holes every 300 mm. This new feature helps guide you during installation and saves time.

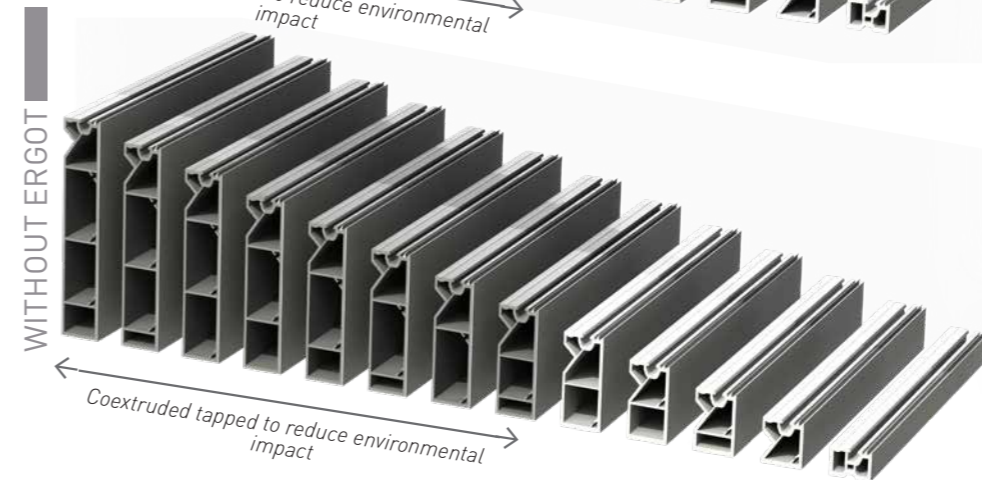
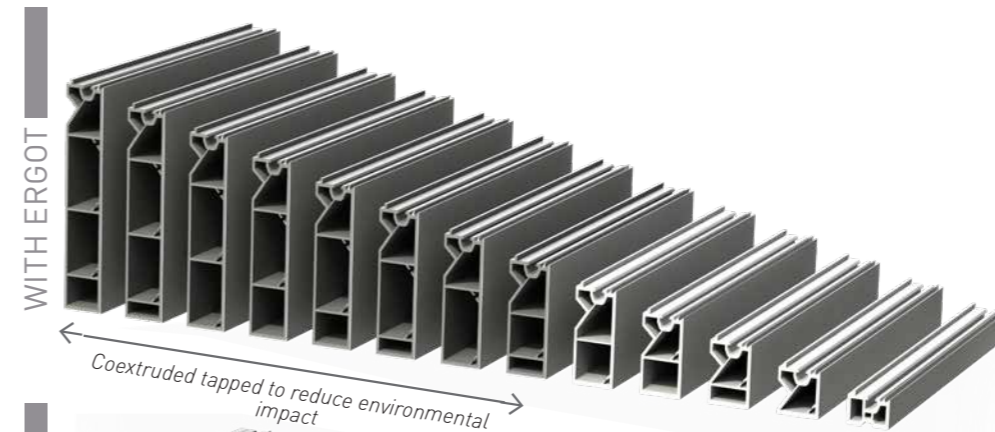

### SEALING PADS FOR TAPPED

Roll of 200 units

**COLORS**  
**OF SEALING PADS**

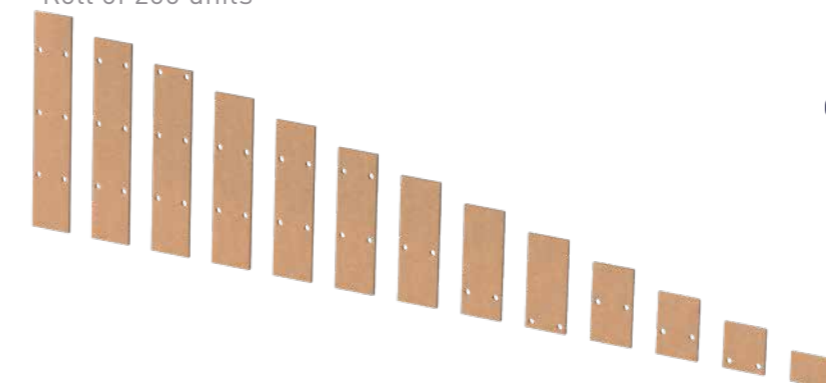

All references are available by the bar (except white)



ME050JC ME050D JC AC104  
17 mm tapped - coextruded seal  
10 bars of 6 ml / pack  
390 bars of 6 ml / container



ME021JC ME021D JC AC105  
27 mm tapped - coextruded seal  
5 bars of 6 ml / pack  
330 bars of 6 ml / container

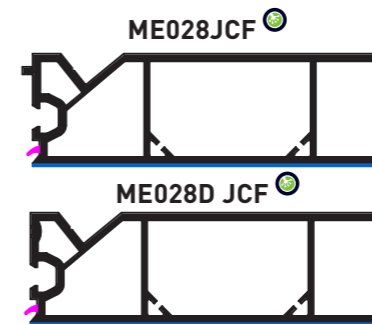

ME028JCF  
ME028D JCF  
Tapped 97 mm - coex + coextruded seal  
3 bars of 6 ml / pack  
100 bars of 6 ml / container

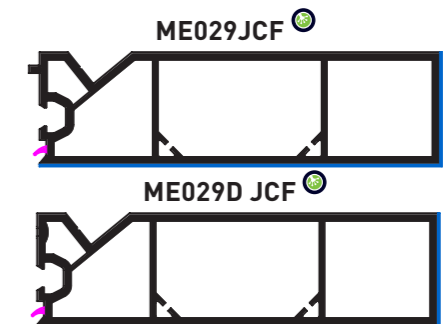

ME029JCF  
ME029D JCF  
Tapped 107 mm - coex + coextruded seal  
3 bars of 6 ml / pack  
90 bars of 6 ml / container



ME022JC ME022D JC AC106  
37 mm tapped - coextruded seal  
5 bars of 6 ml / pack  
240 bars of 6 ml / container



ME023JCF ME023D JCF AC107  
47 mm tapped - coextruded seal  
5 bars of 6 ml / pack  
200 bars of 6 ml / container

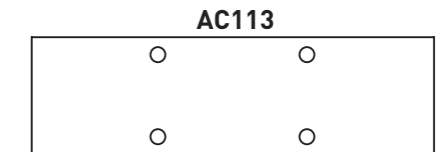
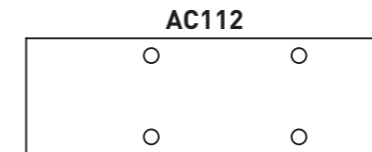

ME030JCF  
ME030D JCF  
Tapped 117 mm - coex + coextruded seal  
3 bars of 6 ml / pack  
80 bars of 6 ml / container

ME031JCF  
ME031D JCF  
Tapped 127 mm - coex + coextruded seal  
3 bars of 6 ml / pack  
80 bars of 6 ml / container

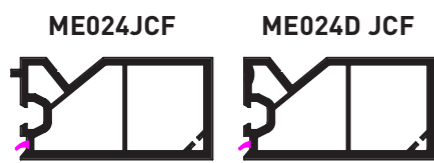

ME024JCF ME024D JCF  
57 mm tapped - coextruded seal  
5 bars of 6 ml / pack  
170 bars of 6 ml / container

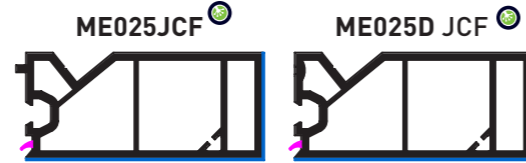

ME025JCF ME025D JCF  
Tapped 67 mm - coex + coextruded seal  
5 bars of 6 ml / pack  
150 bars of 6 ml / container

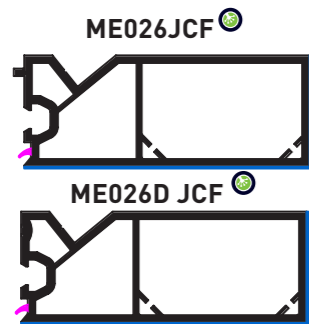
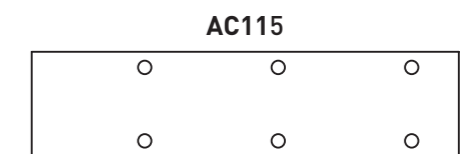
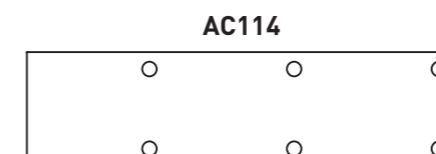
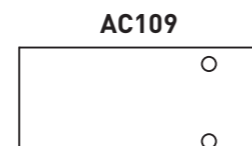
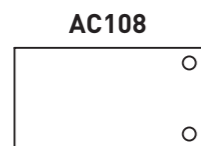

ME026JCF  
ME026D JCF  
Tapped 77 mm - coex + coextruded seal  
3 bars of 6 ml / pack  
120 bars of 6 ml / container

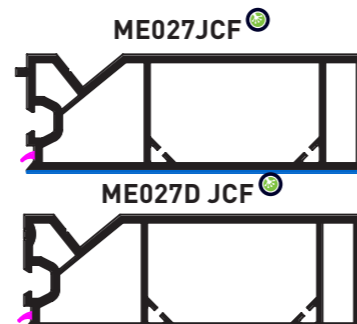

ME027JCF  
ME027D JCF  
Taped 87 mm - coex + coextruded seal  
3 bars of 6 ml / pack  
110 bars of 6 ml / container



ME032 JCF  
ME032D JCF  
Tapped 137 mm - coex + coextruded seal  
3 bars of 6 ml / pack  
70 bars of 6 ml / container

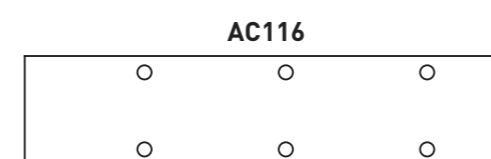
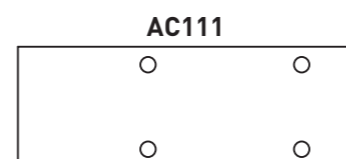
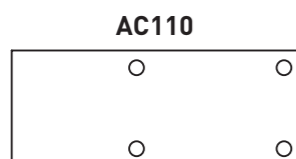

**TAPPED INSERTS COLORS  
MASS COLOURED**

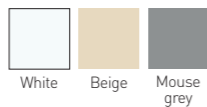

**PLAXED**



80+ plated film decors available on request

**IMPLEMENTATION**

**BLOCK SCREW - PAC036**  
SPK/5-48/GS - 4 x 10  
1 000 pieces / box



**SCREW - PAC037**  
SPT/24-4,3 x 30 GS  
1 000 pieces / box

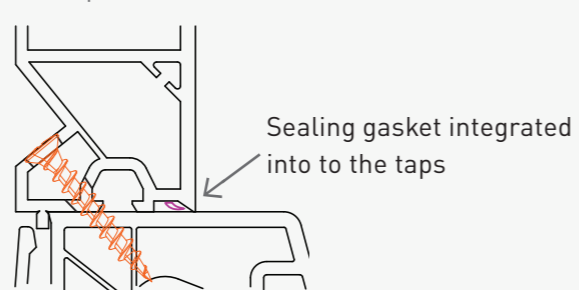

**THEY ARE ALWAYS AVAILABLE ON OFFER  
SEALING PLATES**

**AC009**  
for ME050JCF, ME021JCF, ME022JCF ME023JCF and ME024JCF

Rolls 291 pieces / package - white  
Rolls 277 pieces / package - black

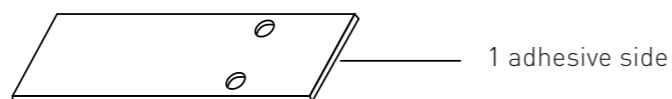

**AC018**  
for ME025JCF, ME026JCF, ME027JCF, ME028JCF, ME029JCF,  
ME030JCF, ME031JCF and ME032JCF

Rolls 291 pieces / package - white  
Rolls 277 pieces / package - black

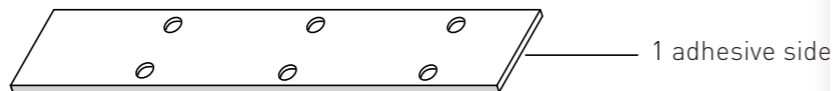

**TAPPED**

**ME080**  
Tapped 165X24

3 bars of 6 ml / pack  
84 bars of 6 ml / container



**COLORS  
MASS COLOURED**

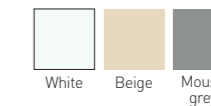

**PLAXED**

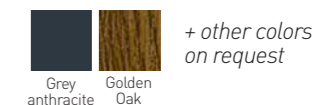

**CONFIGURATIONS**

Examples of possible edgings of the tapped **ME080**.

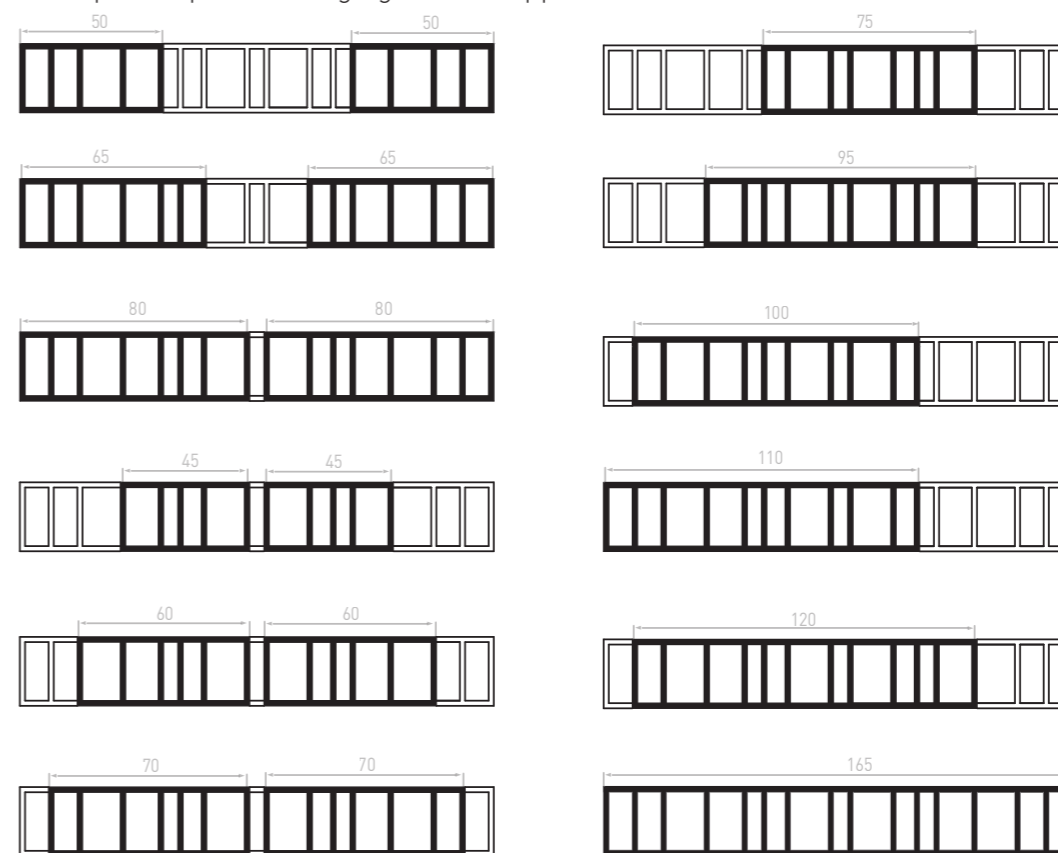

**GLAZING BARS**

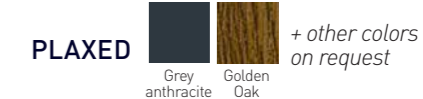

**NEW**

**ME073B**  
Glazin bars 28X7 +  
2 adhesive strips 6 mm  
20 bars of 6 ml / pack

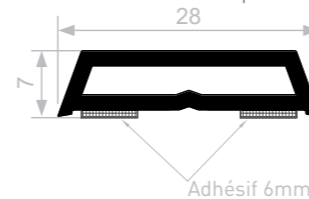

Plaxed : also available by the bar

**ME071B**  
Glazin bars 28X8,5 +  
adhesive strips 6 mm  
20 bars of 6 ml / pack

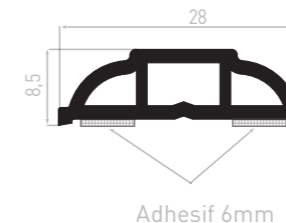

**ME072B**  
Glazin bars 28X9 +  
adhesive strips 6 mm  
20 bars of 6 ml / pack

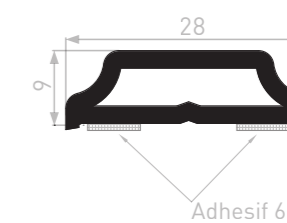

## > DRAINAGE CHANNELS

### ME060

Ogee drainage channel clip-on

30 bars of 6 ml / pack  
600 bars of 6 ml / container

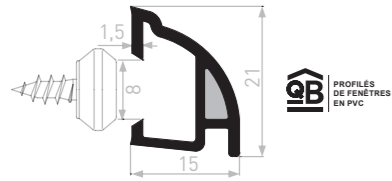

#### COLORS MASS COLOURED

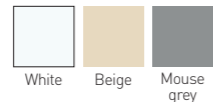

#### PLAXED

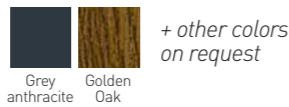

### PIM002

Drainage channel end plate for ME060

500 pairs tied or separated / bag



#### COLORS MASS COLOURED

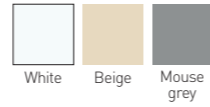

+ other colours on request

### ME061A\*

Door sill drainage channel + adhesive strip 6 mm

20 bars of 6 ml / pack

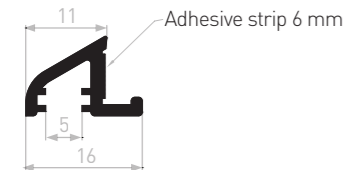

\*Minimum order required 600 ml

#### COLORS MASS COLOURED



### SCREW FASTENING

The ME060 drainage channel is fastened using an SFS block screw, reference: SPF/5-84/GS

### CERTIFICATE (NF)126

To receive the NF certificate for the ME060 profile, please contact our customer service department : [commercial@geplast.fr](mailto:commercial@geplast.fr)

## > CONNECTING PROFILES

\*Minimum order required 600 ml

#### COLORS MASS COLOURED



### ME065

Connecting profile 60 mm

10 bars of 6 ml / pack

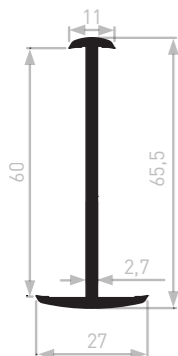

### ME069

Connecting profile 70 mm

10 bars of 6 ml / pack

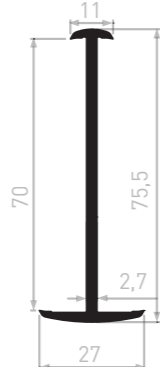

### ME068

Connecting profile 71 mm

10 bars of 6 ml / pack

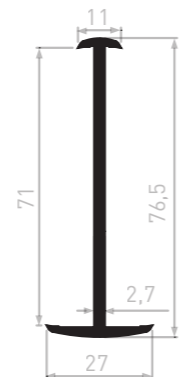

## > JOINT COVER

\*Minimum order required 720 ml

### ME066A\*

joint cover 27 mm + adhesive strip 9 mm

30 bars of 6 ml / pack  
800 bars of 6 ml / container

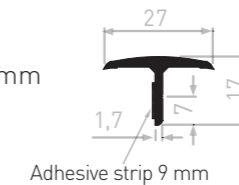

Adhesive strip 9 mm

#### COLORS MASS COLOURED



## > TRIM MOULDINGS

### AB001

Window trim

10 bars of 6 ml / pack  
10 bars of 6 ml / pack

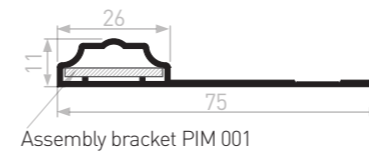

Assembly bracket PIM 001

### AB003

Moulded window trim

10 bars of 6 ml / pack  
10 bars of 6 ml / pack

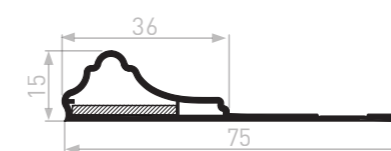

#### COLORS MASS COLOURED

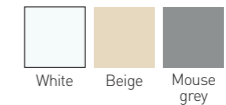

#### PLAXED

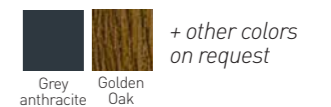

### AB004A

Glued moulded trim + adhesive strip 6 mm

10 bars of 6 ml / pack  
10 bars of 6 ml / pack  
400 bars of 6 ml / container

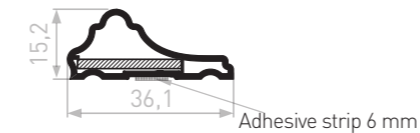

### AB008

Moulded trim

10 bars of 6 ml / pack  
500 bars of 6 ml / pack



### AB021

Trim moulding for 13 mm flange compatible with VEKA

10 bars of 6 ml / pack  
500 bars of 6 ml / pack

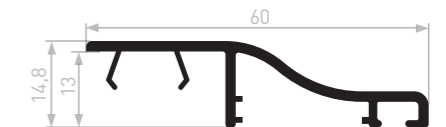

## > ASSEMBLY BRACKET

### PIM001

Black angle bracket

100 parts / bag



#### COLOURS



## > ANGLE COVER

### PIM011

Angle cover for AB021

200 parts / bag



#### COLORS MASS COLOURED

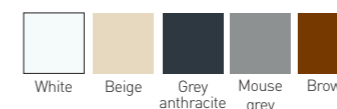

## COMPENSATION BLOCKS

\*Recycled or mass-dyed materials

### ME087B

Compensation blocks 27X18  
+ 2 adhesives strips 12 mm

20 bars of 6 ml / pack  
540 bars of 6 ml / container

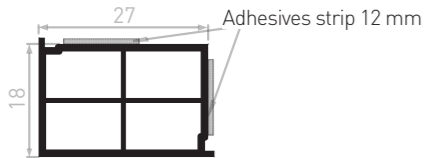

### ME085A

Compensation blocks 25 x 15  
+ adhesive strips 19 mm

20 bars of 6 ml / pack  
700 bars of 6 ml / container

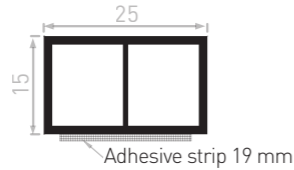

### ME089\*

Filler tube 25 x 15

20 bars of 6 ml / pack  
900 bars of 6 ml / container

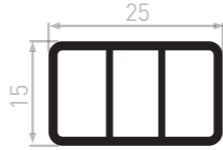

### DI016\*

Support wedge 50 x 17

10 bars of 6 ml / pack  
400 bars of 6 ml / container

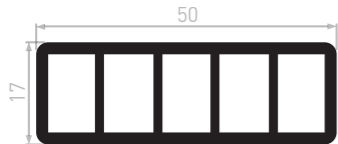

### DI035\*

Support wedge 36x17  
10 bars of 6 ml / pack  
400 bars of 6 ml / container

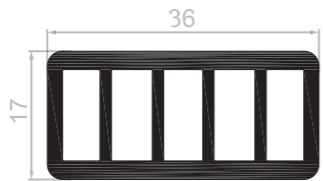

### DI035B\*

Support wedge 36x17 + 2 adhesive  
bars of 6 ml / pack

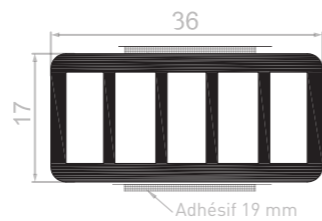

COLORS  
MASS COLOURED



White

### ME086A

Compensation blocks 15X8  
+ adhesive strips 9 mm

20 bars of 6 ml / pack  
700 bars of 6 ml / container

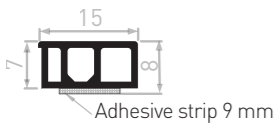

COLORS  
MASS COLOURED

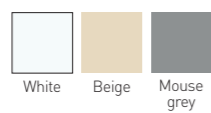

PLAXED

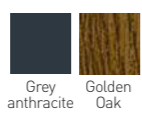

+ other colors  
on request

### ME088A

Compensation blocks 18X10  
+ adhesive strips 12 mm

700 bars of 6 ml / pack

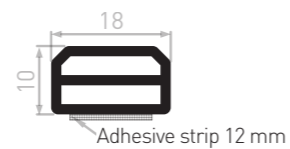

COLORS  
MASS COLOURED



White

## STIFFENERS

### DI018/A

Flat section 50 x 5  
+ adhesive strip 19 mm (option)

10 bars of 6 ml / pack



### DI019/A

Flat section 23 x 6 + adhesive  
strip 9 mm (option)

20 bars of 6 ml / pack



### DI023

Flat section 23 x 8

15 bars of 6 ml / pack



## TRANSPORT BLOCKS

### DI010

Transport block 37X49-PL  
250 mm clip-on

100 units / pallet

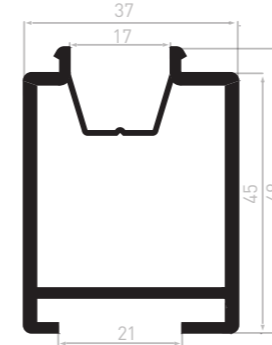

### DI031

15 mm groove clip-on  
Available lengths:  
200 - 250 mm

2 500 units / pallet

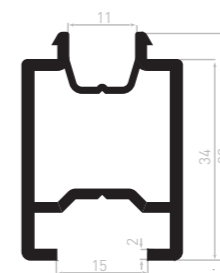

### DI032

32 mm groove clip-on  
Available lengths :  
200 - 250 mm

2 500 units / pallet

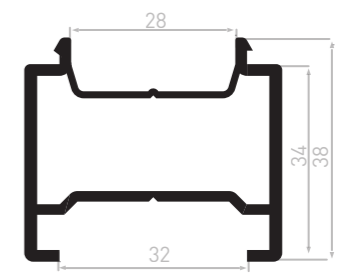

### DI001/A

Transport block 30,5X22

Available lengths :  
120 mm - 200 mm - 250 mm  
+ adhesive strip 6 mm (option)

20 bars of 6 ml / pack  
according to length

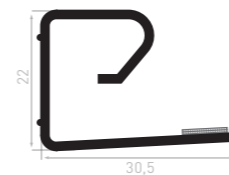

### DI004

Transport block 21x11

Available lengths:  
125 mm - 250 mm  
335 mm - 500 mm

20 bars of 6 ml / pack  
according to length



### DI013A

Protective block 40X22

Available lengths :  
200 mm - 250 mm  
+ adhesive strip 6 mm

20 bars of 6 ml / pack  
according to length

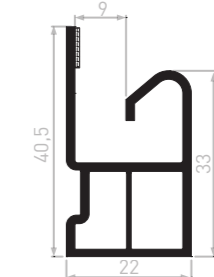

### DI027A

Transport block 54X26

Available lengths :  
200 mm - 250 mm  
+ adhesive strip 6 mm

20 bars of 6 ml / pack  
according to length

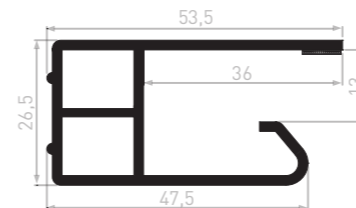

### DI028A

Transport block 32X26

Available lengths:  
125 mm - 200 mm - 250 mm - 300 mm  
+ 2 adhesives strip 6 mm

20 bars of 6 ml / pack  
according to length

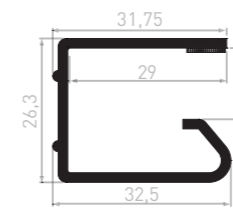



## GENERAL TERMS & CONDITIONS OF SALE

These General Terms & Conditions of Sale can also be viewed on the Internet site [www.geplast.fr](http://www.geplast.fr)

### I – SCOPE OF APPLICATION

Sales by the company GEPLAST (hereinafter 'our Company' or 'us') are subject to these general terms & conditions, which the customer undertakes to fulfil unreservedly and which take precedence over any purchasing condition and any contrary clause stated in the customer's documents, unless formally and expressly waived by us.

No delay or omission by us at any given time in exercising any of these conditions may be interpreted as a waiver to us imposing the aforesaid condition. If one of the conditions specified herein were to be cancelled or rendered unenforceable upon the customer, in whole or in part, the customer would remain bound by all the other conditions.

### II – FORMATION OF THE CONTRACT

Any order received from the customer, whether a proposal or a quotation issued by our company, must be the subject of an order confirmation from us, materialized by the dispatch to the customer of an acknowledgement of receipt of order (or "ARC"). If no reservation is received from the customer within 48 working hours of the dispatch of this order confirmation (ARC), the order is deemed to have been accepted, firm and definitive. The order is then irrevocable, and production begins.

This order confirmation (ARC) is binding for both us and the customer, and is authoritative in the event of any subsequent dispute. Only the order confirmation (ARC) accepted by both parties may deviate from these general terms and conditions. In the event of contradiction with the order confirmation (ARC), only the latter shall prevail.

Our plans, drawings, studies, photos, brochures, catalogs, etc., remain our entire property.

### III – DELIVERY – LEAD TIMES

Unless otherwise stated in our order confirmation, delivery lead times are for guidance only and are not guaranteed. Neither compensation nor contract cancellation shall be granted in the event of delay.

However, in the event of a delay exceeding 8 weeks beyond the guide delivery date, not attributable to a *force majeure* event, the customer may ask to cancel the sale, without penalty to either party, after serving notice without effect. Deposits paid shall be returned to the customer within eight days.

The customer accepts that the products ordered should be delivered in full, or only partially subject to having been duly notified in advance.

In any event, the order can only be fulfilled if the customer is up-to-date with its obligations towards our Company.

### IV – DELIVERY – TRANSFER OF RISKS – RETURNS

The delivery of our goods and their packaging materials is considered to take place in our warehouses. Risks are transferred to the customer once the goods are collected.

The customer has a time limit of 10 days after the goods are made available to be taken into the customer's possession. Beyond this deadline, the risks will be transferred to the customer, who will be liable to pay penalty storage fees equivalent to 1% of the price of the goods, per day of delay, without prejudice to other justified damages and interest.

Upon receipt, the customer or its representative is required to check the goods delivered against the order and to verify their condition.

Our Company waives all liability for errors in quantity, visible damage or defects observed after the delivery note and/or consignment note has been signed.

Defects in part of the delivery are not grounds to reject it in full.

Other than for errors compared to the order or acknowledged defects, the products may not be taken back. No product may be sent back without our prior written consent and our return shipping instructions.

For profiles delivered in metal containers, it should be noted that the containers remain the non-transferable property of our Company and must be returned to us. If not returned, the customer will be invoiced for the cost of the containers (€350 ex VAT each).

### V – TRANSPORT

Unless otherwise agreed, the customer is responsible for transport of the goods.

If we provide the transport or assign it to a third-party carrier, it is expressly agreed that this is at the customer's request and risk, including when the price is specified as 'free delivery'. It is therefore the customer's responsibility to take any necessary measures in the event of damaged or missing items, in accordance with the

provisions of articles L. 133-3 *et sequor* of the French Commercial Code.

Unless formally and expressly waived by us, no clause may be considered as waiving the aforementioned rules.

### VI – GUARANTEE – LIABILITY

In accordance with articles 1641 *et sequor* of the French Civil Code, our products carry the legal guarantee for hidden defects, as well as for visible defects as soon as, in the latter case, these visible defects have been reported by the customer or its representative upon receipt.

For third-party products incorporated into our own products, our Company can agree no greater guarantee than that due from and granted by the suppliers and manufacturers of the aforesaid third-party products.

In all cases, if the non-compliance or defect is acknowledged, our Company's liability shall be limited, at our discretion, either to exchanging or repairing the non-compliant or faulty product or component, or to refunding the order, to the exclusion of any compensation or damages, for any reason whatsoever, particularly for the costs of labor, dismantling, refitting, immobilization or transport, etc.

The guarantee does not apply when the conditions of storage or installation do not follow best practice, or are inappropriate or contrary to our guidelines, in the event of negligence, incorrect cleaning and inappropriate or non-compliant use of our products.

### VII – PRICE – PAYMENT TERMS

Our prices are listed excluding VAT and excluding packaging, and our goods are always invoiced at the price in force on the day of the order confirmation (ARC); VAT is added at the rate in force on the invoice date. Payment costs such as transfer fees, conversion fees, customs fees, etc. are to be paid by the customer

Invoices are payable to our head office 30 days net of shipping, unless otherwise expressly agreed by us. If an order is fulfilled in several deliveries, the invoices relating to each delivery are payable as they are issued without waiting for the entire order to be fulfilled.

In addition, in accordance with the provisions of article L. 441-10 of the French Commercial Code, any delay in payment or any extension of the deadline entails *ipso jure* the application of late-payment interest calculated *prorata*, equal to the interest rate applied by the European Central Bank to its most recent refinancing operation increased by 10 percentage points.

Furthermore, any delay in payment not authorized by our Company results in liability, under a penalty clause for late payment, for fixed compensation set at 10% of the price, as well as payment of the fixed debt recovery allowance of €40 specified in article L. 441-10 of the French Commercial Code, which may be increased by the actually recovery expenses incurred (if greater than the fixed fee).

### VIII – OUTSTANDING PAYMENTS – DEFEASANCE CLAUSE

In the event of failure to pay, forty-eight hours after serving notice without effect, the sale will be cancelled *ipso jure* if we so wish and our Company may seek to have the products returned, without prejudice to any other damages. Cancellation will affect not only the order in question but also all prior unpaid orders, whether they have been or are being delivered and whether or not payment is outstanding.

For payment by bill of exchange, failure to return the bill will be considered as a dishonored bill, comparable to a default of payment. Similarly, when payment is staggered, failure to pay a single instalment will result in immediate liability for the whole debt without notice being served.

In all the above cases, the sums that would be due for other deliveries or for any other reason will immediately become due if our Company does not opt to cancel the corresponding orders. Our Company may also, if it wishes, suspend fulfilment of any current order.

### IX – DETERIORATION IN THE CUSTOMER'S SOLVENCY OR FINANCIAL POSITION

If the customer's solvency or financial position deteriorates, we may, at our discretion, either cancel the order or demand payment or demand additional guarantees. In the event that joint proceedings are taken against the purchaser, we will be able to cancel the order insofar as this is permitted by local law applicable to these proceedings.

### X – FORCE MAJEURE – UNFORESEEN EVENTS

Any *force majeure* event will result *ipso jure* in suspension of deadlines for fulfilling our commitments and will give us the option, as applicable, to cancel them.

Under no circumstances may we be held liable if a *force majeure* event makes it impossible for us to deliver or fulfil the order.

*Force majeure*, in particular as understood in relation to these terms & conditions,

## GENERAL TERMS & CONDITIONS OF SALE

These General Terms & Conditions of Sale can also be viewed on the Internet site [www.geplast.fr](http://www.geplast.fr)

The future takes shape together

include but are not limited to: pandemic, war, mobilization, general or partial strike, lock-out, delay by our suppliers, machine failure, procurement problems for raw

materials, components, equipment or power, fire or any other event over which we have no control, such as to prevent or reduce manufacturing or deliveries.

In the event of a significant modification to the economic conditions in force when we accepted an order, such as to make fulfilment excessively costly for us (particularly the price of the raw material), we reserve the right to negotiate the terms of this order and to cancel it if it is impossible to reach agreement.

### XI – COMPLIANCE WITH OUR RECOMMENDATIONS

Correct use of the products sold by our Company requires our recommendations to be strictly followed, in particular for selection, storage, installation, use and cleaning as specified in our manuals, guides, specifications, catalogues, maintenance sheets and other technical documents.

These documents can be freely viewed on our internet site [www.geplast.fr](http://www.geplast.fr)

These documents can also be handed to the customer on request.

The customer undertakes to bring them to the attention of intermediate and end users.

In any event, the customer undertakes not to make any use or take any action with the products sold without first inquiring about any recommendations regarding the aforesaid products. Failure to follow these recommendations rules out any replacement, repair, refund or compensation of any kind.

In particular, these recommendations include, but are not limited to, the following and are no substitute for carefully reading and closely following the technical documents relating to each product and, if in doubt, first referring back to our Company:

Confirm the compatibility and suitability of the products for the customer's needs

The customer has a duty to confirm the suitability of our products and their technical features for their needs, expectations and uses they plan to make of them.

In the event it is planned to use our products in combination or incorporated with other products for which we have not previously guaranteed compatibility, whether these products come from our Company or third-parties, it is the customer's responsibility first to ensure the suitability and compatibility of the products with each other and more generally the technical feasibility of operation under reasonable conditions.

Confirm the condition of the products before use and commissioning test

The products sold by our Company, whether made from synthetic material (e.g. PVC or ABS) or plant-based/hybrid material (e.g. the Loryza range), may have small manufacturing differences, particularly in their appearance (colour differences, material imperfections, etc.) and small differences in length.

If the products are intended for a specific use, the customer should first perform tests.

Storage and cleaning conditions for the products

Products must be stored and cleaned under normal and usual conditions ensuring they retain their structure, properties and appearance, in particular with regard to unforeseen climatic, atmospheric, temperature, light or other conditions, irrespective of their source, and in all cases complying with our specific recommendations, where they exist. In general, the products must be stored out of sunlight, bad weather and moisture.

In particular, for storage, the products should be stacked on a dry flat surface, in a cool and well-ventilated place, out of the light, so as not to be distorted or discolored.

Profiles made of 100% PVC should be cleaned using warm soapy water with a soft non-abrasive sponge and rinsed with clean water. No solvent, acid, acetone-based or chlorinated product should be used. For storage, cardboard kits such as packs should be laid on a dry flat surface, in a well-ventilated place, to avoid distortion.

### XII – ADVERTISING RIGHT

Any use by the customer of one of our trademarks or company name will be subject to our prior written agreement.

### XIII – PERSONAL DATA

In the context of contractual relations with the customer, our Company employs computerized systems making it easier to manage the customer's order, to meet legal or regulatory obligations and to send sales documents to the customer. Some of the data collected in this way, required to agree or fulfil the contract(s), may relate to one or more identified or identifiable natural persons acting in their professional capacity. In this case they meet the qualification for personal data in the meaning of current national and European regulations. Our Company is then considered as the Data Controller.

In doing so, our Company undertakes under all circumstances to comply with the regulations applicable to processing personal data, and particularly Regulation (EU) 2016/679 of the European Parliament and of the Council of 27 April 2016 applicable with effect from 25 May 2018 (hereinafter 'GDPR') and French law<sup>78-17</sup> of 6 January 1978 on data processing, files and freedoms.

Our Company also undertakes only to involve or work with contractors or partners that also comply with them.

In compliance with the regulations, these data are stored for the duration of the commercial relationship between our Company and the customer, then for a period of 3 years following its end, for statistical purposes, without prejudice to any legal or regulatory obligations for data archiving when they exist and storage made necessary to establish proof of a right or a contract that can be archived in accordance with the provisions of the French Commercial Code.

In any event, natural persons affected by processing of data about them have a right of access, rectification, erasure, restriction of processing, opposition or data portability, the right not to be affected by automated decision-making (including profiling) and a right of appeal to the CNIL (French data protection commission).

### XIV – RETENTION OF OWNERSHIP

**PRODUCTS SOLD REMAIN OUR PROPERTY UNTIL EFFECTIVE PAYMENT OF THE ENTIRE PRINCIPAL AND INCIDENTAL PRICE. IN THIS RESPECT, PROVIDING A BILL OF EXCHANGE OR ANY OTHER SECURITY CREATING AN OBLIGATION TO PAY DOES NOT CONSTITUTE PAYMENT IN THE MEANING OF THIS CLAUSE.**

**FAILURE TO PAY ANY OF THE INSTALMENTS MAY RESULT IN DEMANDS TO RETURN THE PRODUCTS. CUSTOMER UNDERTAKES, UNTIL PAYMENT OF THE FULL PRICE AND SUBJECT TO AN IMMEDIATE DEMAND BY OUR COMPANY TO RETURN THE PRODUCTS, NOT TO TRANSFORM NOR INCORPORATE THE AFORESAID PRODUCTS, NOR TO RESELL THEM OR PAWN THEM.**

**IN ANY EVENT, THE PRODUCTS STILL IN THE CUSTOMER'S POSSESSION ARE CONSIDERED TO BE THOSE FOR WHICH PAYMENT IS OUTSTANDING.**

**THE CUSTOMER ALSO UNDERTAKES TO NOTIFY US IMMEDIATELY OF ITS SUSPENSION OF PAYMENTS, OR TO SUBMIT ITSELF OR BE SUBJECT TO JOINT PROCEEDINGS FOR RECEIVERSHIP OR COURT-SUPERVISED WINDING UP ON REPORT OF EXISTENCE IN ITS STOCK OF UNPAID GOODS BELONGING TO US AND TO SUPPLY US ANY INFORMATION ENABLING US TO DEMAND THE RETURN OF GOODS FROM SUBSEQUENT PURCHASERS.**

**THESE MEASURES ARE NO OBSTACLE TO TRANSFER TO THE CUSTOMER, AT DELIVERY, THE RISKS OF LOSS OR DAMAGE OF THE PRODUCTS SOLD, AS WELL AS DAMAGE THAT THEY COULD CAUSE.**

### XV – APPLICABLE LAW – SETTLEMENT OF DISPUTES

**ALL DISPUTES RELATING TO OUR SALES AND TO FULFILMENT OR INTERPRETATION OF OUR GENERAL TERMS & CONDITIONS OF SALE ARE SUBJECT TO FRENCH LAW AND WILL BE SOLE JURISDICTION OF THE NANTES (FRANCE) COMMERCIAL COURT, EVEN FOR A GUARANTEE CLAIM OR WHERE THERE ARE MULTIPLE DEFENDANTS.**

Date :

Last name, First name:

Signature preceded by the mention "Read and approved"

# GEPLAST

*Building*

GO TO  
[WWW.GEPLAST.FR](http://WWW.GEPLAST.FR)

GEPLAST SAS  
Z.I. Actipôle Nord 249  
6, rue de Beauséjour  
Saint-André-de-la-Marche  
49450 SÈVREMOINE  
Phone : 02.41.49.80.90  
Fax : 02.41.46.42.07

*Non-contractual document. We reserve the right, at any time and in order to improve our profiles, to make any modifications we consider necessary.*