



*The future is coming together.*

# OUTDOOR LAYOUT

APRIL 2023

**GEPLAST**   
*Outdoor*





## OUR REASON FOR BEING

We like to recharge our batteries, go for a walk, cultivate our vegetable garden, smell the perfume of the roses at the end of spring, receive our guests around a big table, watch the children playing on the swing, offer a game of pétanque to our neighbor... the garden has become a second home where one seeks to create singular spaces.

GEPLAST Outdoor is designed to secure your property, to delimit your living spaces and to create new ones...

So welcome and let's start by taking a look at the owner...

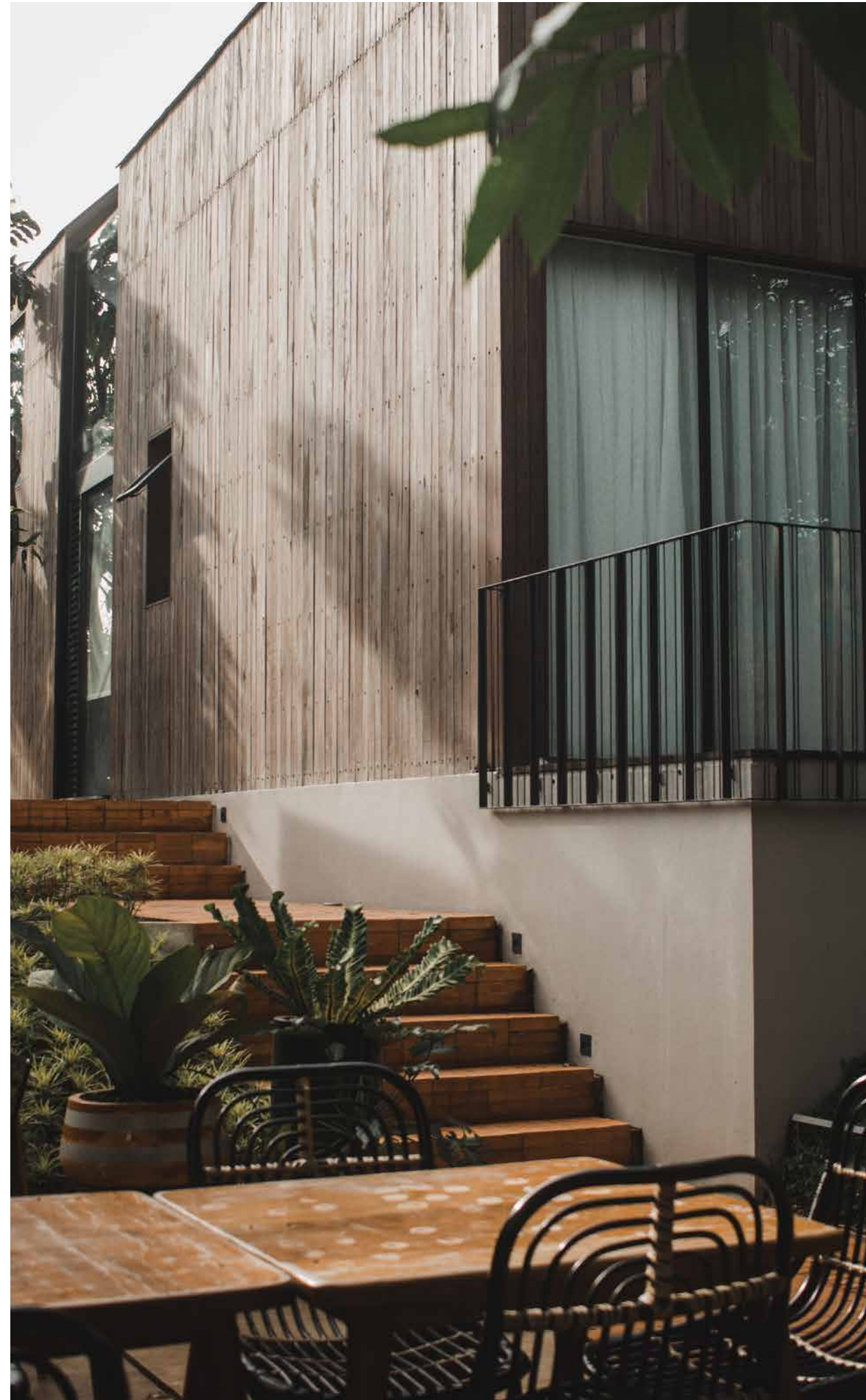

## SUMMARY

4	GEKO 
6	THE MATERIALS
8	OUR RANGES
10	SISTÄ
38	<b>NEW</b> SISTÄDEL
41	CLEANING PRODUCTS AND FINISHING PENS
42	SITADEL
56	GATES & FENCES SURFACE-MOUNTED FRAME
68	<i>STORAGE POSTS</i>



# GEKO

Eco-designed by nature

From the outset, the products in the GEKO range are part of a **decarbonized** and **sustainable life cycle**. As a matter of principle, and as far as possible, recycled materials will be used. **All offcuts are sorted, crushed and re-extruded.**

In addition to recycled material, GEKO uses alternative composites, from almost inexhaustible agricultural resources or bio-sourced materials.

In the manner of a "gecko", a type of lizard found in many parts of the world, the products in the range meet three basic requirements :

- **eco-responsibility** → nature
- **product quality** → agility
- **customized solutions** → great adaptability

A symbol of Geplast's commitment to environmental protection, GEKO is a new green experience in the history of building, simply because it is "Eco-designed by nature".

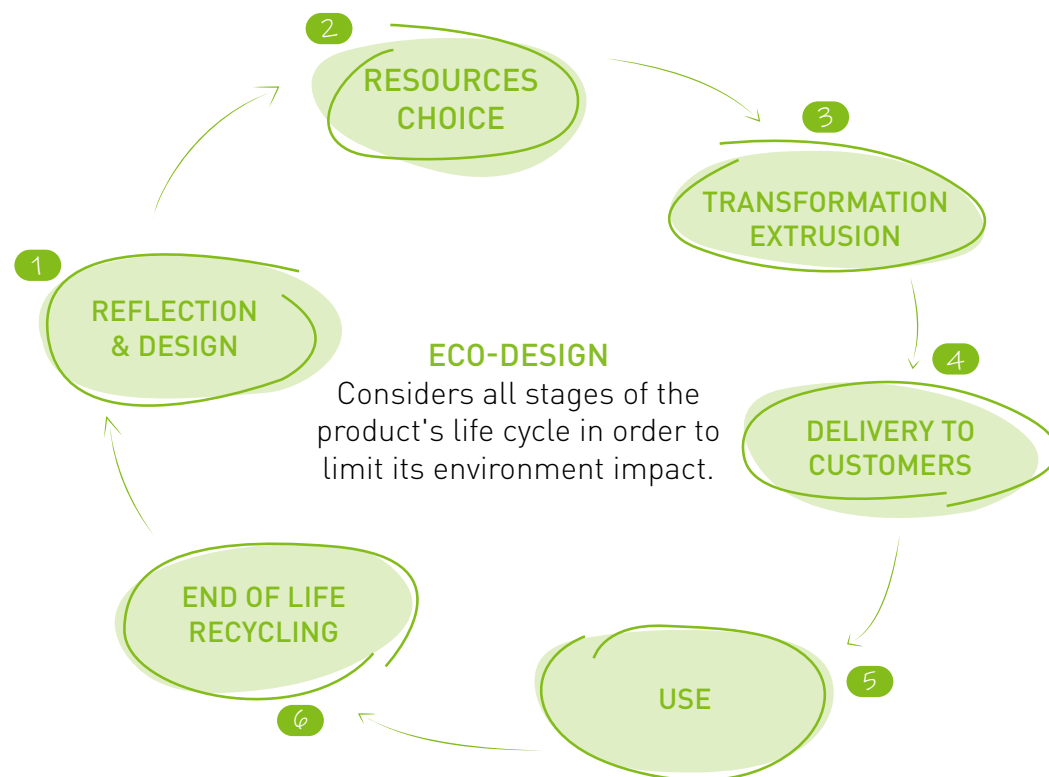

# 37%

of our processed materials are recycled materials, or 2,773 tons in 2022.

## RESOURCES CHOICE

- 100% recycled PVC, obtained through the management of our offcuts transformed into extruded co-products or from our local recycling partners.
- Use of bio-sourced materials such as Loryza®. Composed of 60% natural material (rice husk), it contains a much lower proportion of petroleum than virgin PVC.

At Geplast, 200 tons of recycled material are used per month to make our products, representing 30% of our total production.

*At Geplast, 200 tons of recycled material are used per month to make our products, representing 30% of our total production.*

## TRANSFORMATION EXTRUSION

We favor co-extrusion\* for the development of our GEKO products. The visible outside is made of 0.5 mm of virgin material to keep the technical aspects on the surface and the inside is made of recycled material.

The eco-design of our products also involves thinking about energy savings, for example by changing the cooling system of our machines. They will be more energy efficient.

*\*This extrusion process makes it possible to obtain a product combining two different formulations to form a single product.*

## REFLECTION & DESIGN

Reflection is the starting point for the design of a product. So we think about the composition of the products, the technical performances we want to obtain as well as the materials to use. The goal is to reduce our environmental footprint as much as possible.

## END OF LIFE RECYCLING

The lifespan of PVC products is 30 years. They are then recovered and recycled by waste treatment companies. Once this step is completed, Geplast takes back the recycled material to create new profiles and products.

## DELIVERY TO CUSTOMERS

The next step is to deliver our customers. To limit our carbon footprint, our deliveries are optimized to avoid round trips.

## USE

Our customers generate co-products;

## REDUCING OUR FOOTPRINT

The eco-design of our products also involves reducing our carbon impact. Since 2018, Geplast's R&D department and the firm EVEA have been conducting a study to calculate the carbon costs of our recycled materials and measure the energy consumption of some of our extrusion lines. This questioning is formalized by the EPR which should be implemented in 2023 and which should over the years require manufacturers to establish Life Cycle Analyses (LCA) in order to produce Environmental and Sanitary Declaration Sheets (ESDS) for each product, which will be published in the Inies database and verified by the control bodies.



# THE MATERIALS

*"Because it takes good products and know-how to design good profiles."*

As for many products, the quality of the raw material is a key condition. This is even more true for products related to the world of outdoor design, permanently exposed to the vagaries of the weather (rain, wind, heat, humidity ...). With this in mind, GEPLAST has chosen to source almost exclusively from a resin manufacturer recognized for its expertise in order to extrude 100% French profiles in its Saint-André-de-la-Marche (49) plant.

Fully integrated in a continuous improvement process, the raw material is certified and controlled at all stages of production, allowing us to guarantee it over the long term.



## PVC THE GUARANTEE OF DURABILITY

PVC is a 100% recyclable material with many advantages: multi-purpose, resistant to external aggressions (UV, precipitation, fire), non-oxidizing, easy to maintain, decorative and with excellent insulating properties.

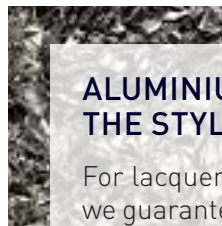

## ALUMINIUM THE STYLISH SURE THING

For lacquered aluminum products, we guarantee a sufficient thickness of lacquer layer, its adherence, its good polymerization, its resistance to corrosion and the resistance of the color of your gate to UV and outdoor exposure.

For plated aluminum products, we provide a 15-year warranty on the color and durability of the films.

ALU  
MARKING  
LABEL

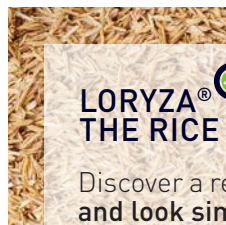

## LORYZA® THE RICE HUSK THAT REINVENTS WOOD

Discover a resolutely contemporary material that offers a touch and look similar to wood but without its constraints.



ECO  
RESPONSIBLE

### A PRODUCT WITH HIGH ADDED VALUE

- > No splinters
- > Pleasant to the touch
- > Easy to clean
- > Waterproof
- > UV resistant
- > No splintering
- > No decomposition
- > Resistant to insects and fung
- > Customizable customizable

### A UNIQUE AND AWARD-WINNING MATERIAL

Loryza® is made from rice husks, a hitherto little-used food residue that requires no specific cultivation or deforestation. It is a particularly exceptional material because of its intrinsic qualities and the comfort it provides in terms of stability, feel and maintenance. Loryza® is an **eco-responsible product and is guaranteed for 15 years.**

### AWARDED PRIZES



PRODUCT DESIGN AWARD  
Category Design Materials 2016

## Please read carefully before installing any of our outdoor products

Before starting the work, check that all the profiles are homogeneous in color and that they are not scratched. Depending on the collection chosen, the PVC profiles can undergo slight variations in color. For our rice hull based products, slight variations can be observed from one strip to another depending on the origin of the hull.

For storage, carton kits and packages should be placed on a dry, level surface in a well-ventilated area out of direct sunlight so that they do not distort.

In case of sun exposure, dark and plaxed colors can cause a deformation of the boards by dilation of the external face: bimetal effect. The characteristics of the site, and particularly the exposure to the sun, are major elements that we do not control. If the product supplied does not meet these characteristics, the customer will be held solely responsible. To limit this effect, we recommend the use of ALU reinforcements in dark-colored PVC and Loryza® slats and panels from 1m20 in length.

The length of the profiles must be checked and cut if they are too long.

The gate models are compatible with conventional motorization systems, for swinging or sliding openings.

Concerning the accessories (hinges, clamps...), we ask you to inquire with your usual supplier.

Touch-up pens are available for plated colors.

Geplast SAS declines all responsibility and will cancel its guarantee in case of non-compliance with the above instructions for use.

*Non contractual document. We reserve the right at any time and in a concern of evolution of our profiles, to bring all modifications which we will judge useful.*



# OUR RANGES

## Sistä



Make your fence a decorative element to enhance your garden. The SISTÄ range is resistant to bad weather, frost and salt air and is available in 4 collections: Prestige, Trend, Simplicity and Authenticity.

Prestige, the new collection offers all the posts and accessories in plated ALU. You will be able to coordinate your structures and fillings thanks to the different colors and even give a real wood look to your fence!

The Tendance collection relies on a mix of materials: ALU, PVC and Loryza®. This combination ensures modernity and robustness.

Simplicity, this 100% PVC collection offers a wide range of colors to meet all your desires.

The Authenticity Collection is the 100% Loryza® fence that provides a wood-like appearance without the constraints.

To give originality to your exteriors, the SISTÄ range can also accommodate the BRIZÄ filling and our two decorative panels «broken glass» and «plant».

## Gates & fences surface-mounted frame



The range of gates and fences with surface-mounted frames has been modernized.

Discover the new references with more refined, modern and harmonious lines that are consistent with all our ranges.

## Sitadel



SITADEL is a range of gates with clean and contemporary lines composed of 2 collections: **Prestige and Tendance**. Also, it harmonizes perfectly with the SISTÄ range of fences.

SITADEL is available in both swing and sliding gates and can meet all technical needs and aesthetic desires. Its little plus? Its structure is invisible, which allows the same appearance on each side.

The **Prestige Collection** is the big news of this year 2023! Resistant to external aggressions due to its composition in ALU, this plated collection offers many colors and possibilities. Its manufacture is simple and fast, thanks to a simplified machining.

The **Tendance collection** leaves the choice of filling to the user and allows you to mix materials according to your desires: Loryza®, PVC, ALU.

## How to choose your gate

**Opening**  
**Slider**  
 Saves space. Responds to a problem of setback on your property.

**Casement**  
 Allows the size of the leaves to be adapted to the terrain.

**Privacy**  
**Obscure**  
 Provide a deterrent effect. Be protected from prying eyes.

**Confidence**  
 Protect children and animals. See without being seen.

**Overview**  
 See completely outside. Bring in the light.

**Shape**  
**Right** **Bias**





**GEPLAST**  
Outdoor

# SISTÄ 4 COLLECTIONS

**NEW**

**PRESTIGE COLLECTION**

p.12



ALU plaxed

**SIMPLICITY COLLECTION**

p.16



100% PVC

**TRENDY COLLECTION**

p.20



Mix of materials  
Loryza®, ALU or PVC

**AUTHENTICITY COLLECTION**

p.24



100 % Loryza®

## The colors

Find out the color guarantee chart from a sales representative.

### ALUMINUM - LACQUERED FINISHES



WHITE RAL 9016 MAT ANTHRACITE GREY RAL 7016 GRANITE BLACK RAL 2100 SANDED



### PVC - TINTED FINISHES



COTTON WHITE 9016 IVORY BEIGE 1015

COLORIS GUARANTEED 10 YEARS



MURRY GREY GREY 7042 TAUPE GREY 7039

COLORIS GUARANTEED 2 YEARS

### LORYZA®



LORYZA NATURAL LORYZA TONKA LORYZA GRANITE LORYZA BLACK

### ALU & PVC PLAXED FINISHES

COLORIS GUARANTEED 15 YEARS

Frame, structure, post and accessory profiles are the only profiles available in plated ALU.



ANTHRACITE GREY QUARTZ GREY GOLDEN OAK MATTE BLACK WHITE MATTE MATTE GREY

### Woodec



ANTEAK PEPPER OAK TURNER OAK MALT SHEFFIELD OAK ALPINE SHEFFIELD OAK CONCRÈTE TURNER OAK TOFFEE



# SISTÄ PRESTIGE COLLECTION

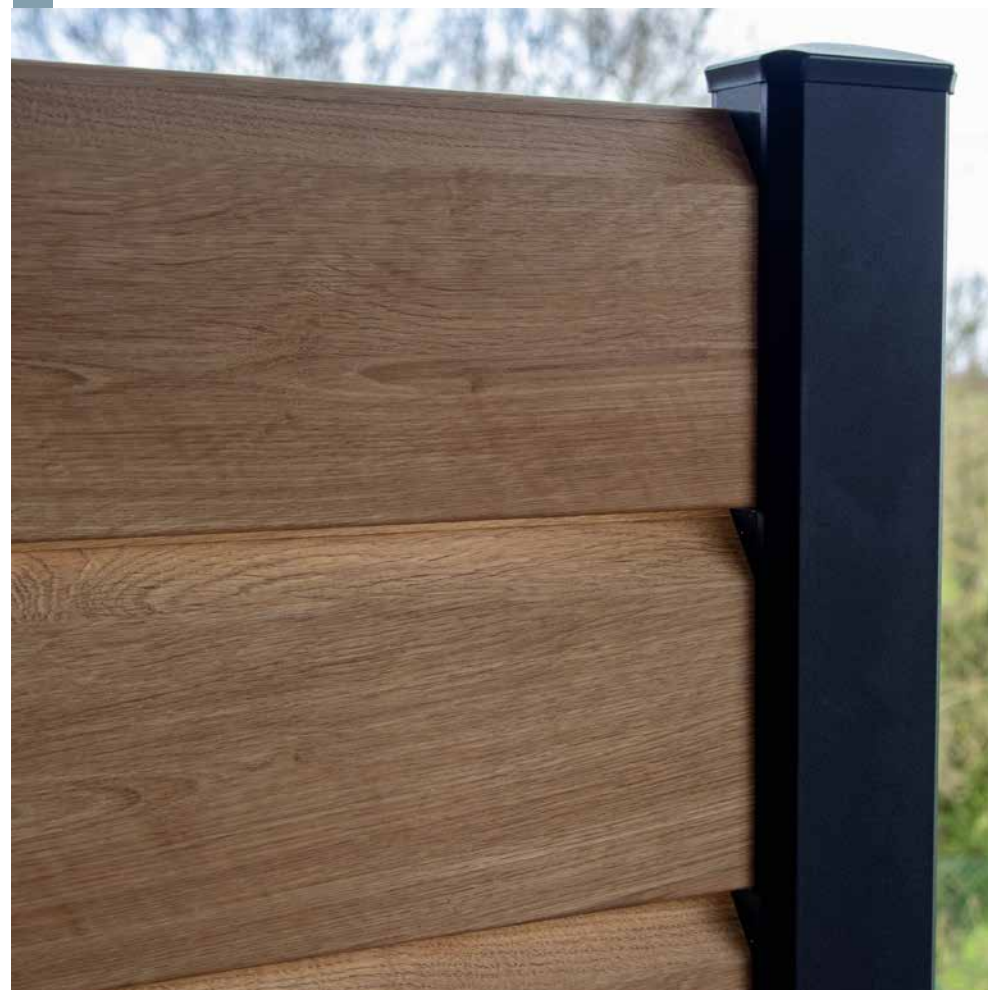

*Prestige Collection: plaxed or Loryza® finishes.*

## ALU plaxed



Prestige is the very first fence collection to offer all of its ALU structure profiles and accessories in a plaxed ALU finish.

It offers a wide choice of plaxed finishes with 12 films that can be combined according to your desires.

Discover the 7 «wood» look finishes, a unique offer on the outdoor market.





## The profiles Prestige Collection

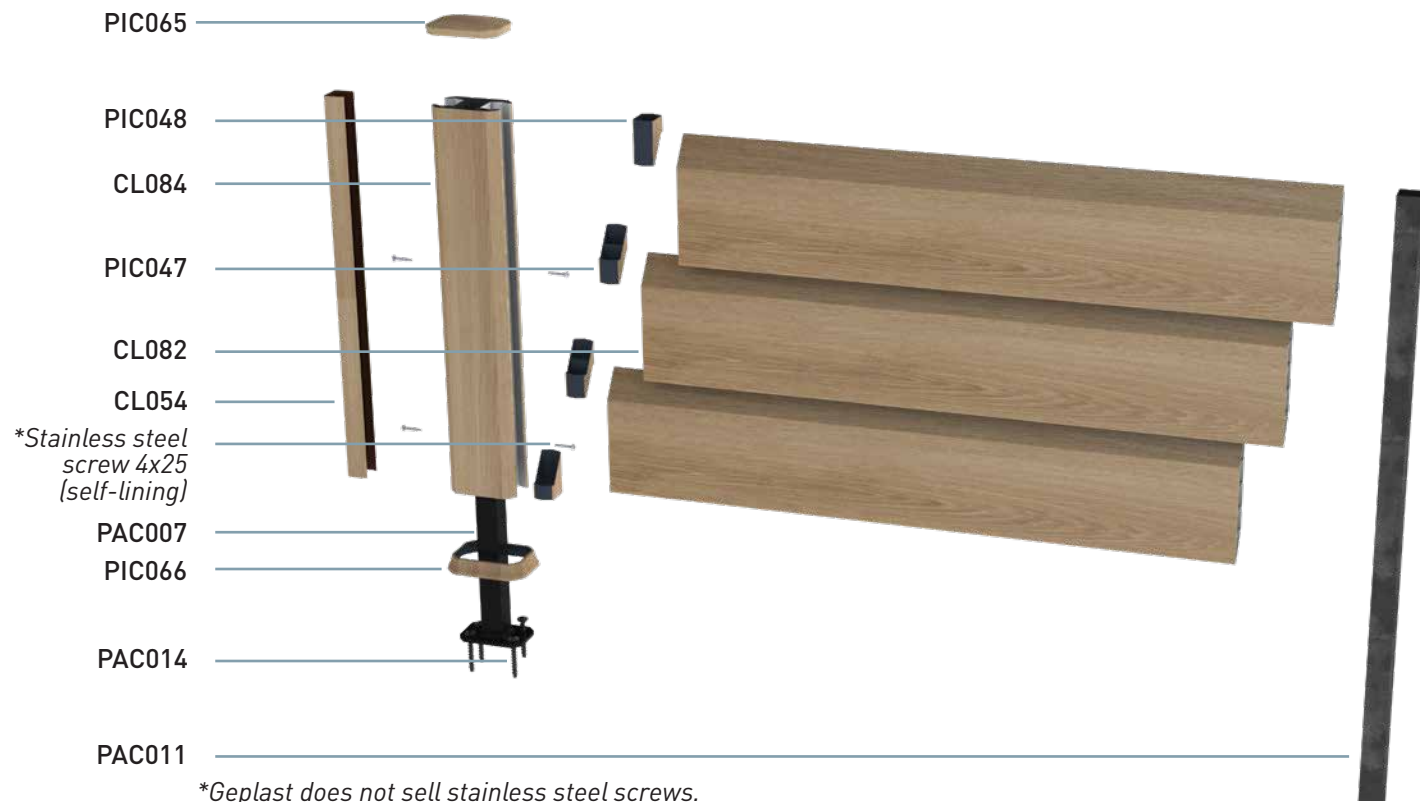

\*Stainless steel screw 4x25 (self-lining)

\*Geplast does not sell stainless steel screws.

## Article coding

Discover all the colors on pages 10-11 and on request.

### > STRUCTURE

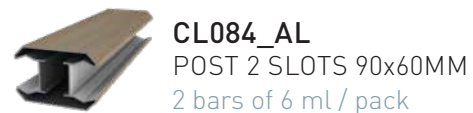

### > UNTREATED ALU STIFFENERS

We recommend the use of reinforcements in dark-colored PVC and Loryza® slats and panels and Loryza® panels from 1.20 m in length.

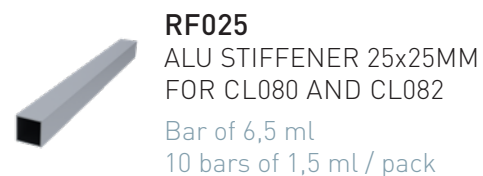
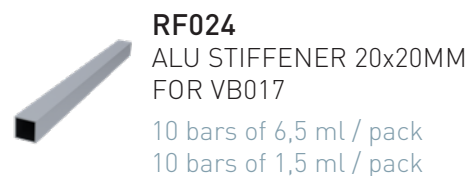

### > ACCESSOIRES

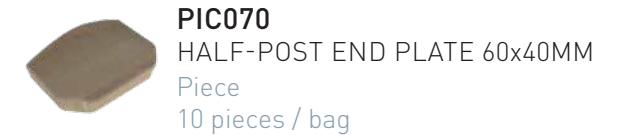
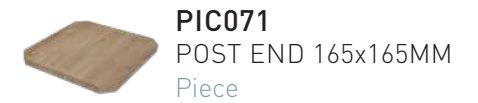
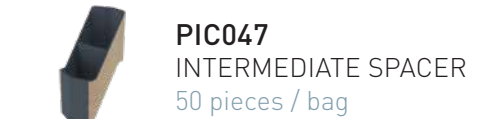
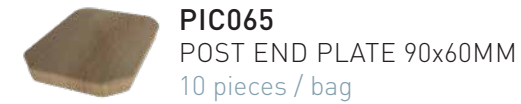

### > FILLER PANELS

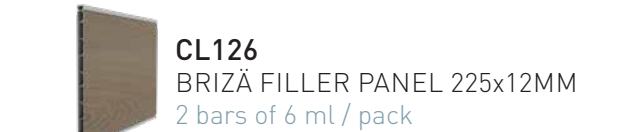

### > STEEL FASTENINGS

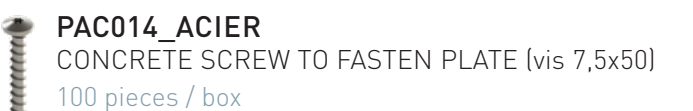
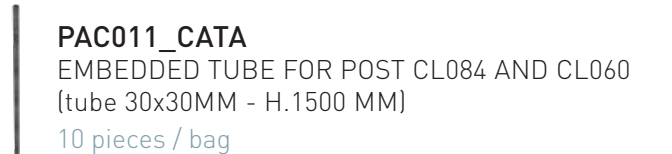



SISTÄ **SIMPLICITÉ**  
COLLECTION



*Simplicity Collection : plaxed finish*

100% PVC



Simplicity, the 100% PVC collection from the Sistä range.

Structure and decorate your garden with ease. With its openwork filling and mass tinted finishes, the simplicity collection will meet all your desires.





## The profiles Simplicity Collection

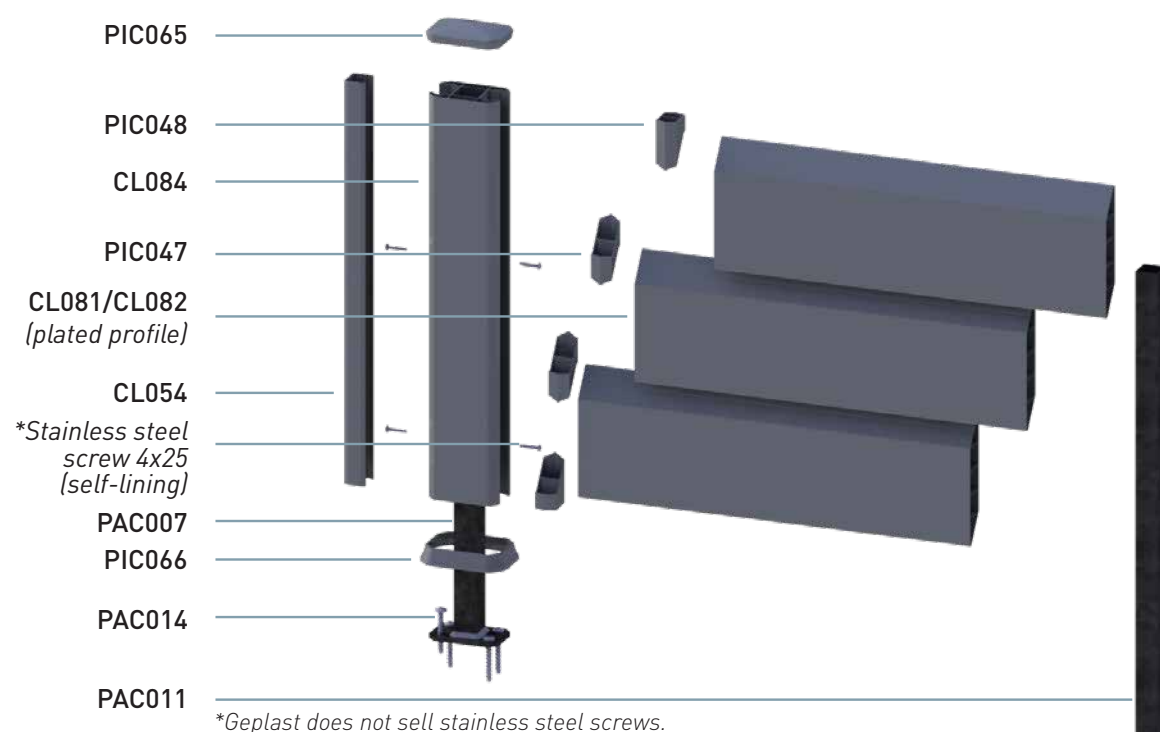

### Article coding

Discover all the colors on pages 10-11 and on request.

### STRUCTURE

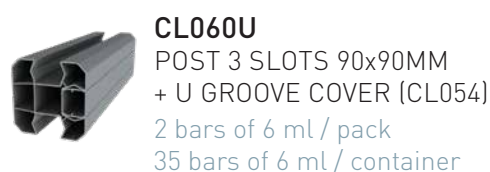
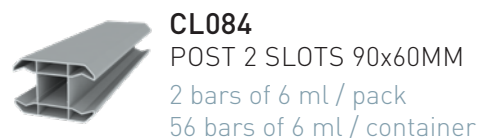
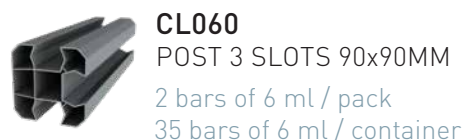

### UNTREATED ALU STIFFENERS

We recommend the use of reinforcements in dark-colored PVC and Loryza® slats and panels and Loryza® panels from 1.20 m in length.

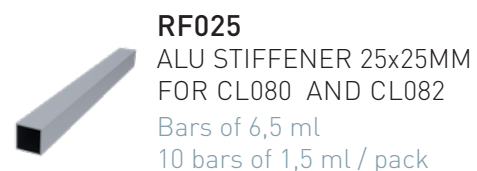
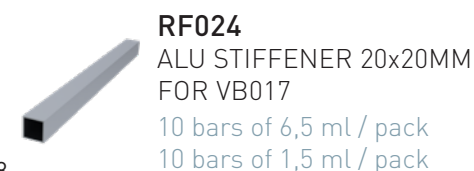

### PVC ACCESSOIRES

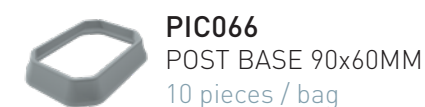
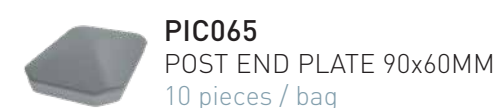
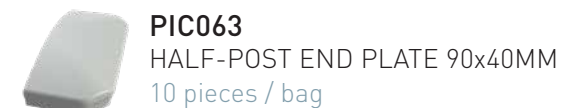
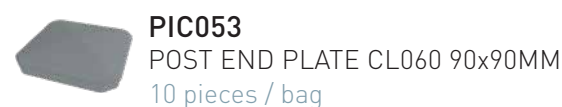
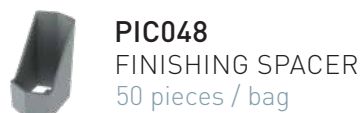
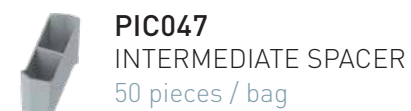

### FILLER PANELS

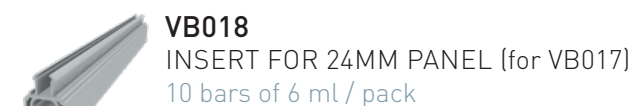

### STEEL FASTENINGS

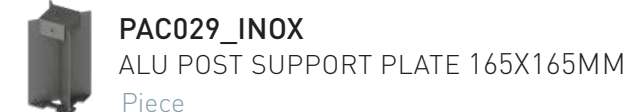
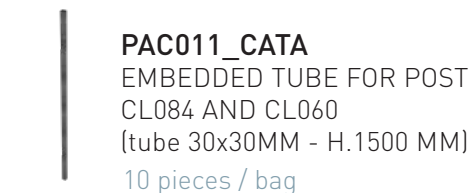
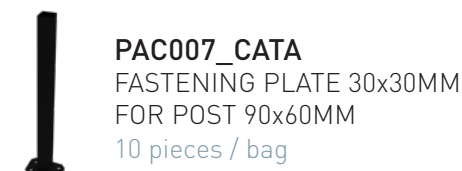

# SISTÄ TENDANCE COLLECTION

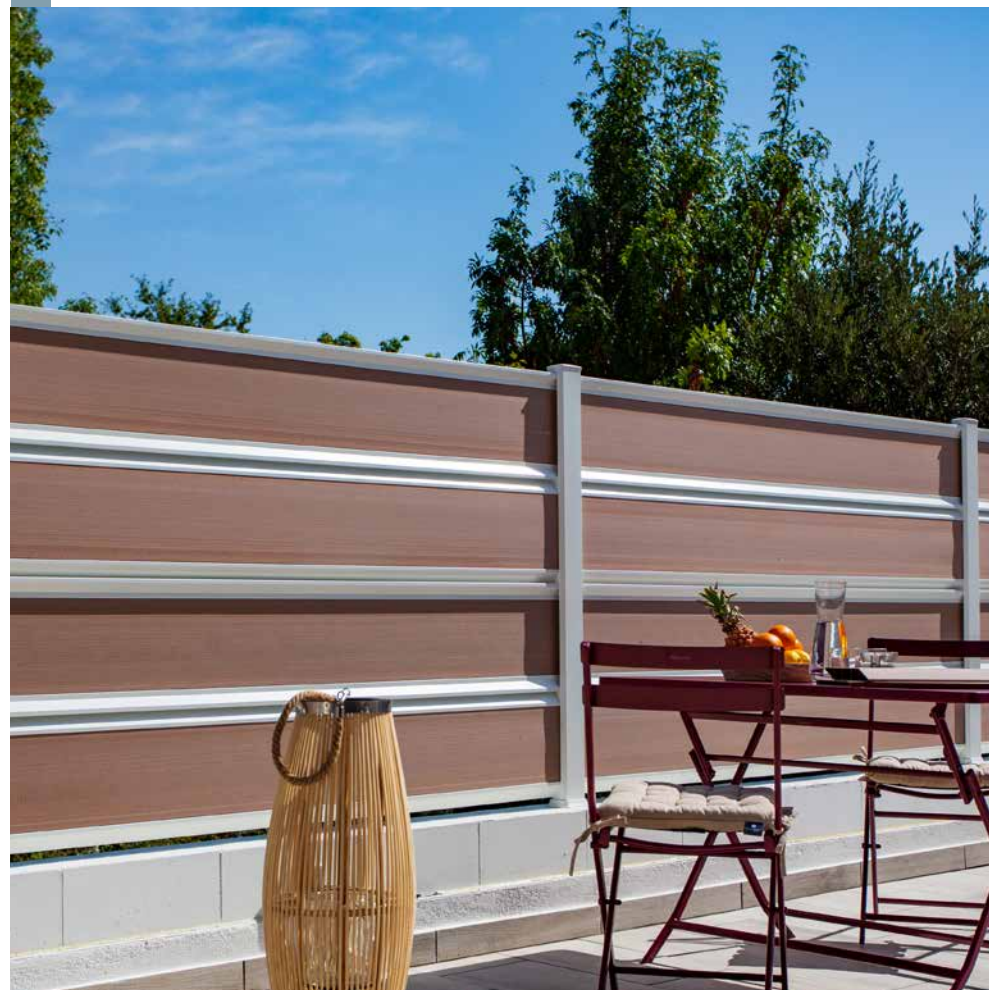

*Trend Collection: stained, plaxed, lacquered and Loryza® finishes.*

## The mix of materials



Trend, the collection that allows you to mix materials to give more originality to your exteriors.

Its aluminum structure ensures resistance and durability. And, for the filling it is your choice: Loryza®, ALU or PVC.



## The profiles Trendy collection

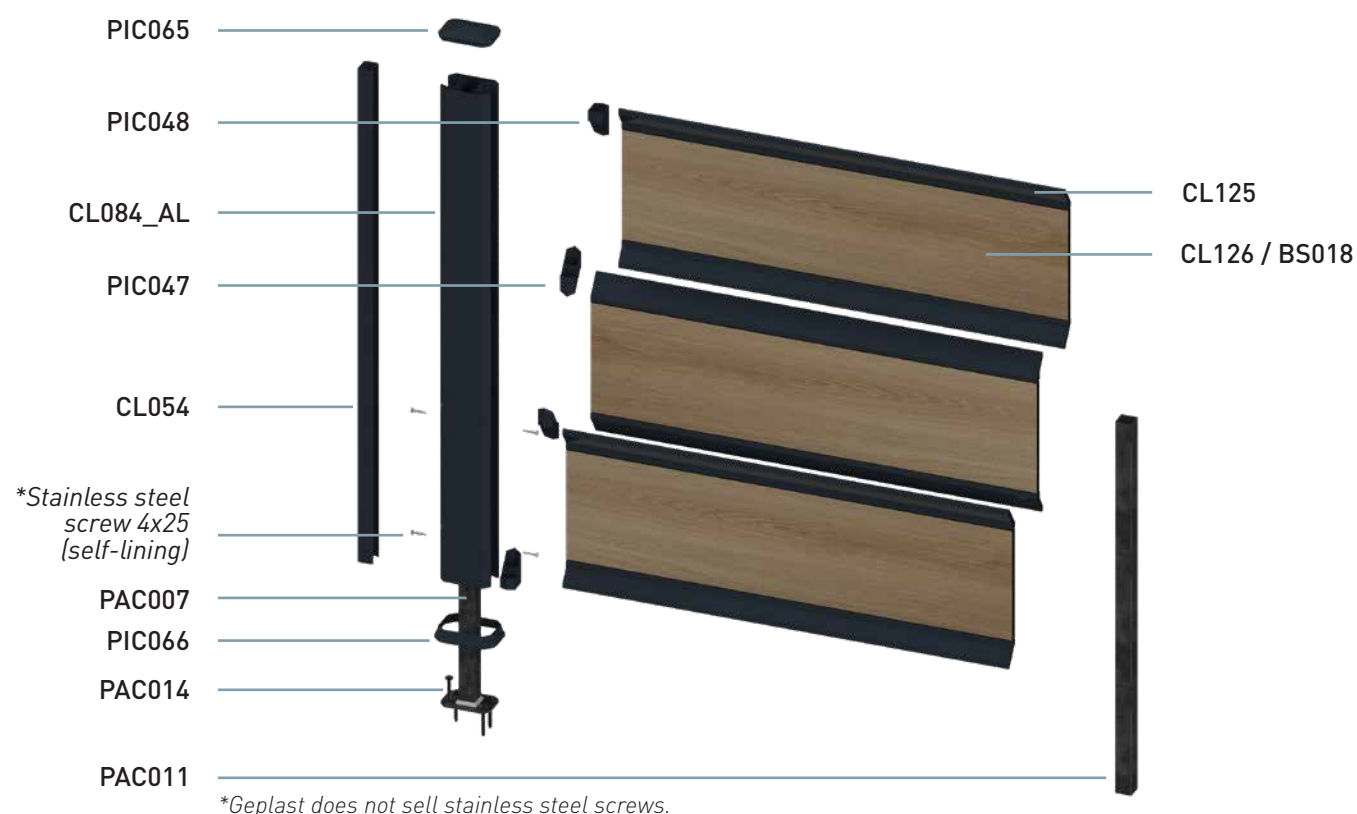

## Article coding

Discover all the colors on pages 10-11 and on request.

### > STRUCTURE

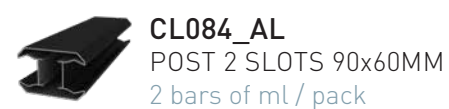

### > UNTREATED ALU STIFFENERS

We recommend the use of reinforcements in dark-colored PVC and Loryza® slats and panels and Loryza® panels from 1.20 m in length.

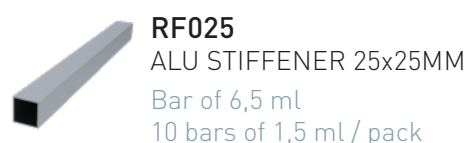
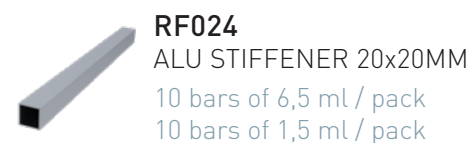

### > PVC ACCESSOIRES

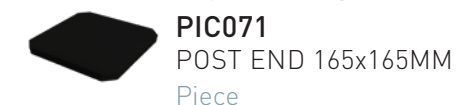
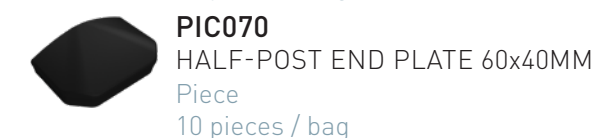
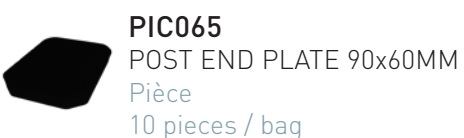
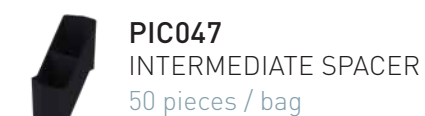

### > FILLER PANELS

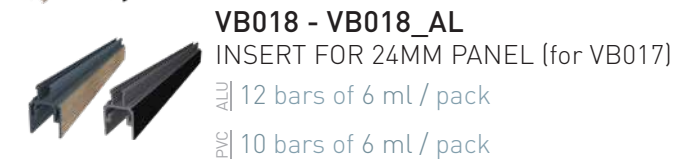
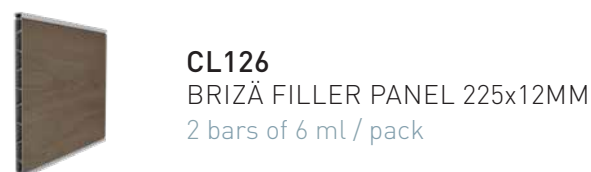

### > LORYZA® FILLER PANELS



### > STEEL FASTENINGS

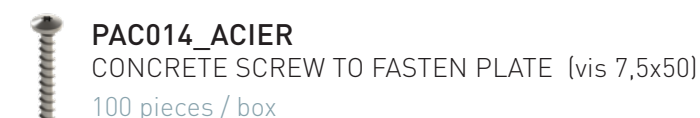
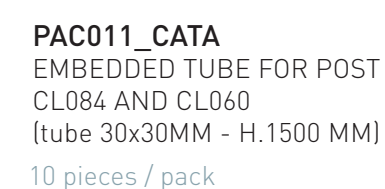
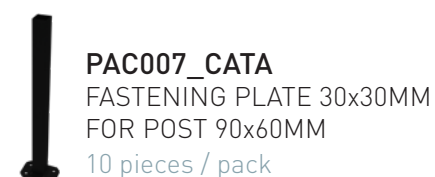

SISTÄ **AUTHENTICITÉ**  
**COLLECTION** 

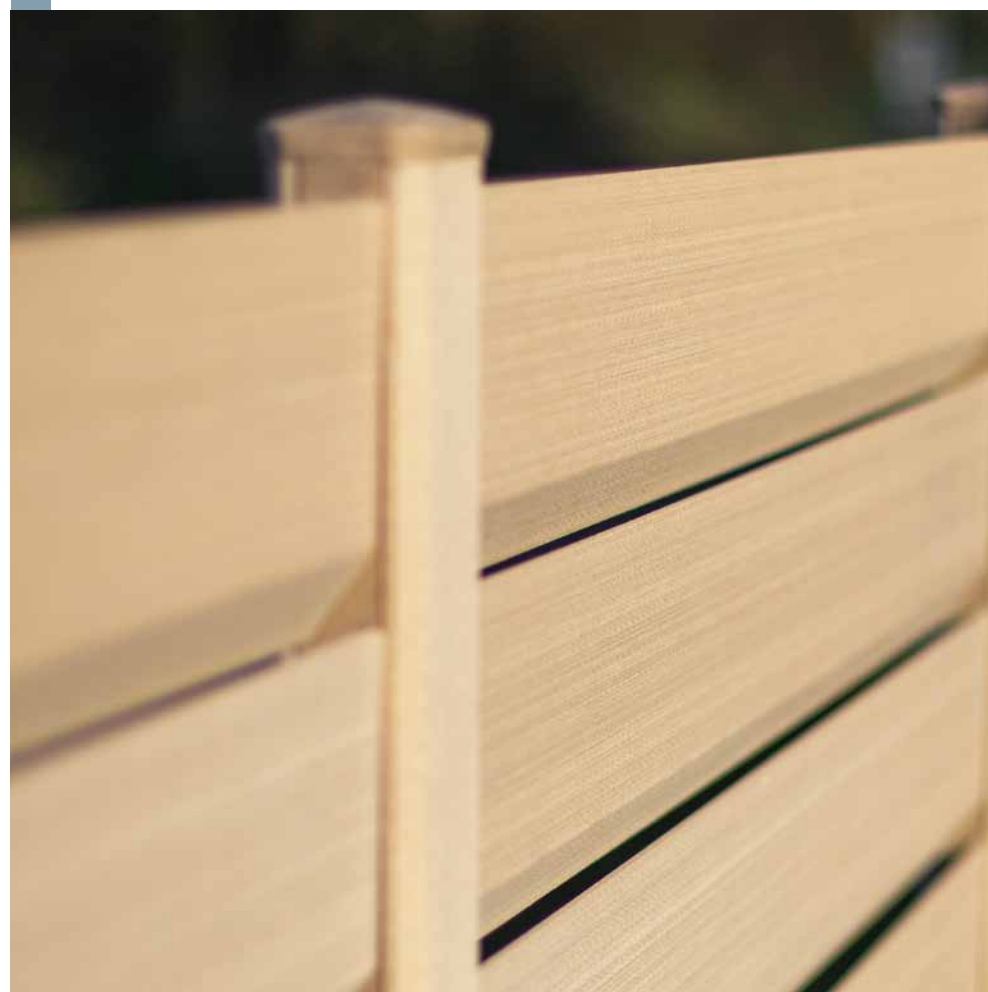

*Authenticity Collection: Loryza® finish.*

**100 % Loryza®**



Opt for naturalness with the Authenticity collection, the 100% Loryza® fence that gives you a look similar to wood but without its constraints.





## The profiles Authenticity Collection

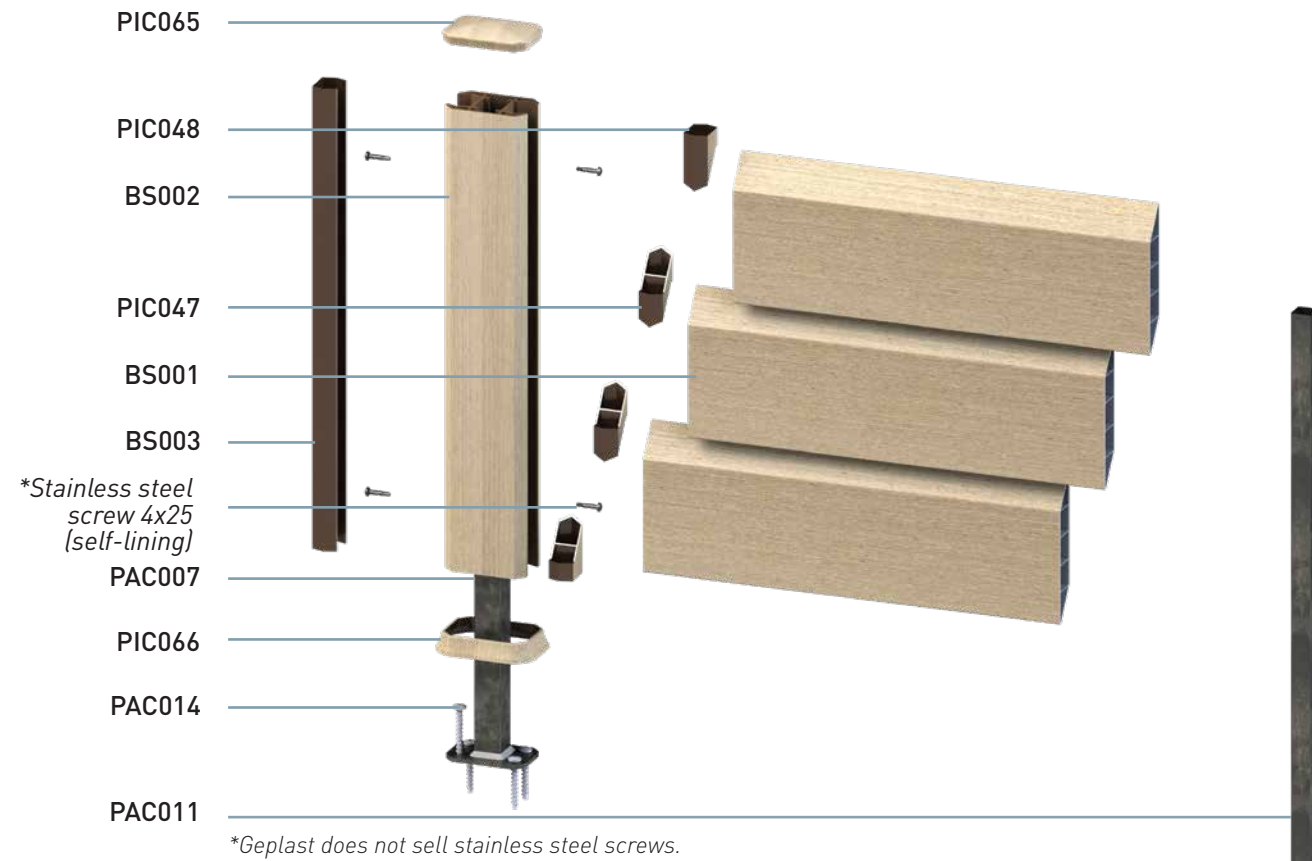

## Article coding

Discover all the colors on pages 10-11 and on request.

### > STRUCTURE



### > UNTREATED ALU STIFFENERS

We recommend the use of reinforcements in dark-colored PVC and Loryza® slats and panels and Loryza® panels from 1.20 m in length.

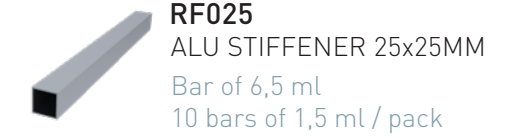
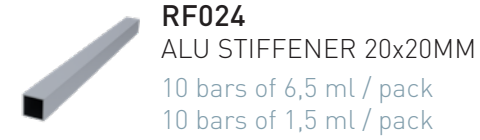

### > LORYZA® ACCESSOIRES

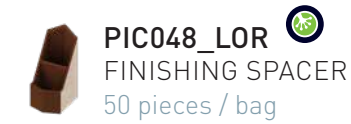
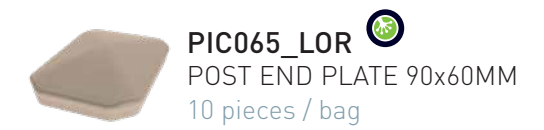
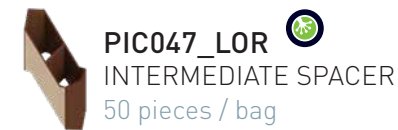

### > FILLER PANELS

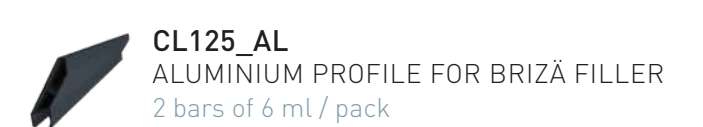
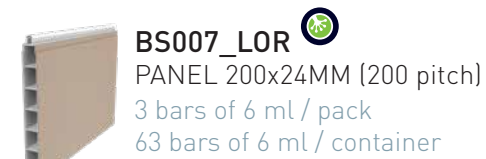

### > STEEL FASTENINGS

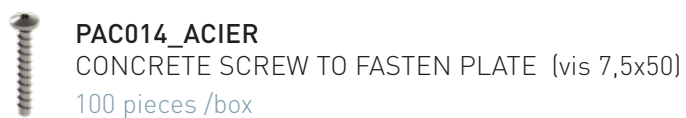
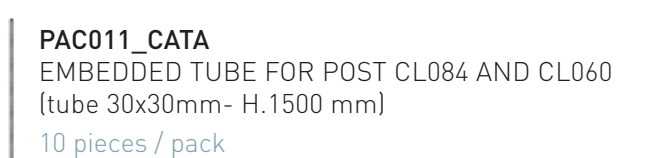



# DECORATIVE PANEL SISTÄ FENCES



## Article Coding

### > DECORATIVE PANEL FOR BRIZÄ FILLER

CL130 | By unit

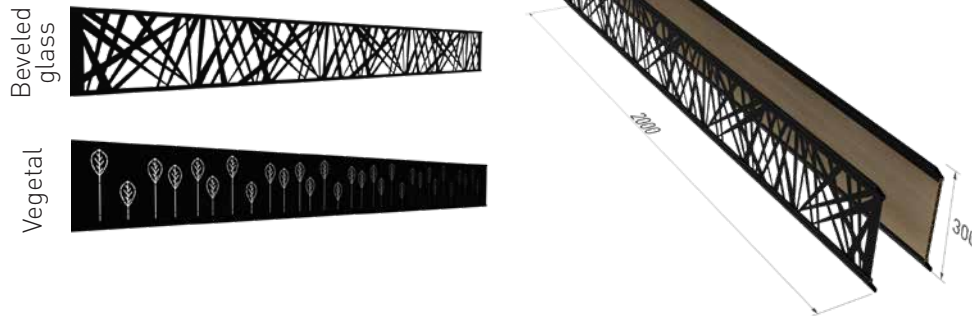

#### LACQUERED COLOURS



### > DECORATIVE PANEL FOR SISTÄ PRIVACY FENCE

CL131 | By unit

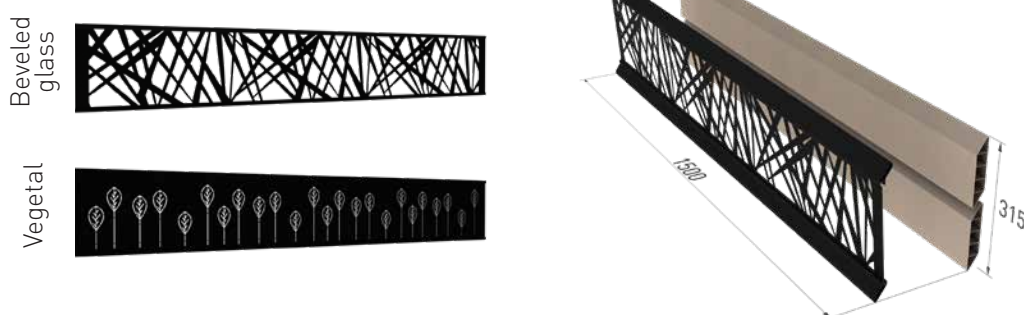

## Assembly principle



To install your decor panel, refer to the assembly principle on page 35 step 8.  
**Be careful not to forget the CL125 profiles.**



## TECHNICAL MANUAL SISTÄ

### Full height chart with panel, insert and finish profiles

This assembly is done by using the U-shaped groove cover as a reducer. Principle to be used for all fillings of 24 mm thickness.

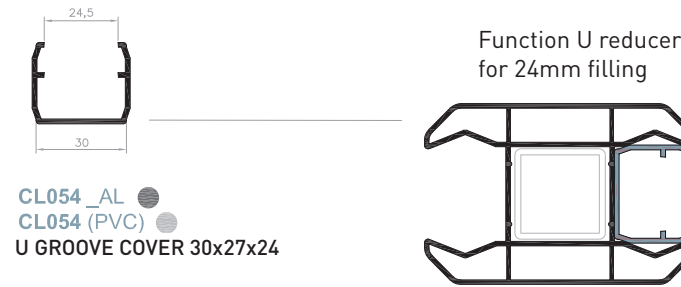

CL054\_AL  
CL054 (PVC)  
U GROOVE COVER 30x27x24

	Post height*	Number of panels
	CL084 CL084_AL	VB017 OR VB017_AL OR BS007 AND 1 VB019 OR VB019_AL
Embedded tube L.1500 mm PAC011	1835	9
	1635	8
Screwed plate H.400 mm PAC007	1435	7
	1235	6
	1035	5
	835	4
	635	3
	435	2
	235	1

Maximum centre spacing between posts for ALU panels = **2046 mm**  
Maximum centre spacing between posts for PVC or Loryza® panels = **1546 mm**  
Installation on plate, maximum height = **1300 mm**

\* For each additional VB018 (PVC) or VB018\_AL (ALU) insert, please add 15.5 mm for the height of the posts.



Example of assembly with 2-slot post - CL084



## Height calculator open-worked with privacy slat

	Post height CL084 - CL060U - CL084_AL		Number of slats	Number of spacers (start/end) PIC048	Number of intermediate spacers PIC047
	For 160 privacy slat CL081 CL081_AL CL082 BS020	For 135 privacy slat CL080			
Embedded tube L.1500 mm PAC011	1905	1605	12	4	22
	1750	1475	11	4	20
	1595	1345	10	4	18
	1440	1215	9	4	16
Screwed plate H.400 mm PAC003 ou PAC007	1285	1085	8	4	14
	1130	955	7	4	12
	975	825	6	4	10
	820	695	5	4	8
	665	565	4	4	6
	510	435	3	4	4
	355	305	2	4	2
	200	175	1	4	0

Maximum centre spacing between posts for ALU slats = **2046 mm**

Maximum centre spacing between posts for PVC or Loryza® slats = **1546 mm**

Installation on plate, maximum height = **1300 mm**

### with BRIZÄ slat

	Post height	Number of slats	Start/end spacers	Intermediate spacers
Embedded tube L.1500 mm PAC011	CL084_AL	2 x CL125 + 1 x CL126 or BS018	PIC048	PIC047
	1815	6	4	10
	1520	5	4	8
Screwed plate H.400 mm PAC007	1225	4	4	6
	930	3	4	4
	635	2	4	2
	340	1	4	0

Maximum centre spacing between posts = 2046 mm

Installation on plate, maximum height = **1300 mm**

## Choice of post

> IDEAL FOR A FENCE WITH ANGLE RETURN

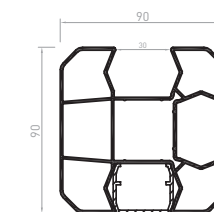

**CL060**  
**CL060U (CL060+CL054)**  
Post, 3 slots 90 x 90

PVC ●

> IDEAL FOR A STRAIGHT FENCE

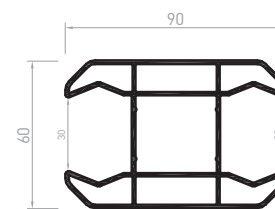

**CL084**  
Post 2 slots 90 x 60

PVC ●  
ALU ●  
Loryza® ●

> IDEAL FOR A FENCE RENOVATING AN EXISTING WALL

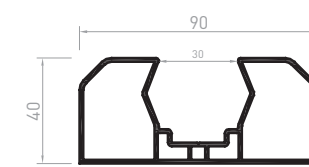

**CL061**  
Post 1 slots 90x40

PVC ●

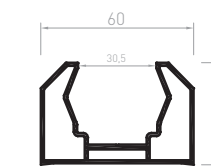

**CL099\_AL**  
Post 1 slots 60x40

ALU ●

> IDEAL FOR BRIDGING THE GAP BETWEEN THE FENCE AND THE GATE

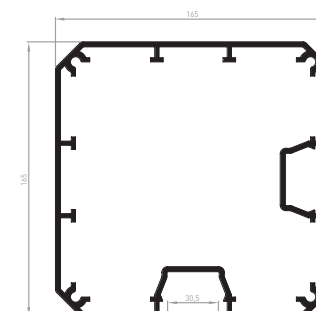

**CL127\_AL**  
Post 165x165

ALU ●

## CLEANING PVC - ALU

PVC and aluminium are cleaned in the same way: wash using warm soapy water with a soft nonabrasive sponge and rinse with clean water.

**Precautions:** Never use solvent, acid, nor acetone-based or chlorinated products.

## CLEANING LORYZA®

**Maintenance:** No special cleaning (apart from normal cleaning) is required.

**Cleaning:** Dirt can be cleaned off easily using a low-pressure (garden) hose. A soft brush can be used for stubborn marks. If these marks remain, they can be lightly sanded (40-60 grit).



After installing your fence, we recommend rinsing Loryza® filler panels with a hose to remove dust due to brushing. This will avoid rings forming after the first rain.



# SISTÄ installation instructions

**STEP 1** Prepare the centre spacing between the posts

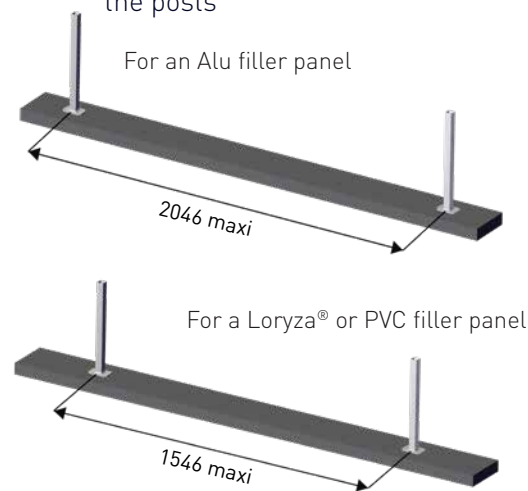

This measurement includes allowance for expansion

**STEP 3** Cut the posts to the desired height (refer to the height chart on page 30).

**STEP 4** Slide the U groove covers into the first and last post of your fence.

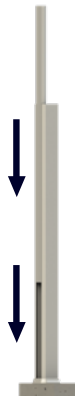

**STEP 6** (a) Slide on the end plates and then (b) insert the reduction profile for the solid version and the starting spacers for the openwork version.

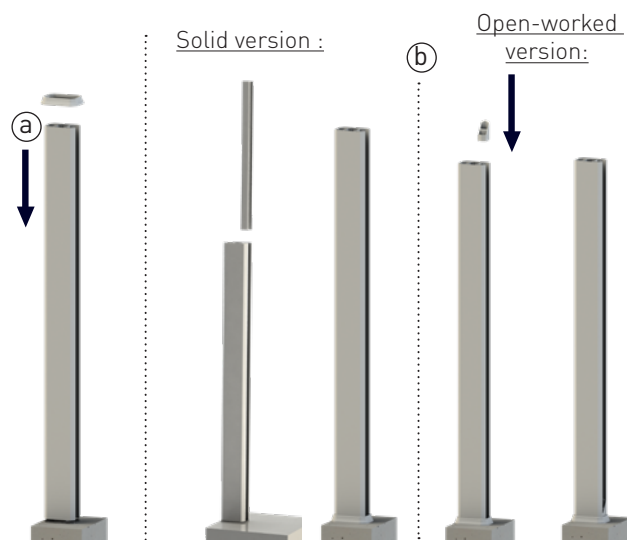

**STEP 2** Fasten the supports

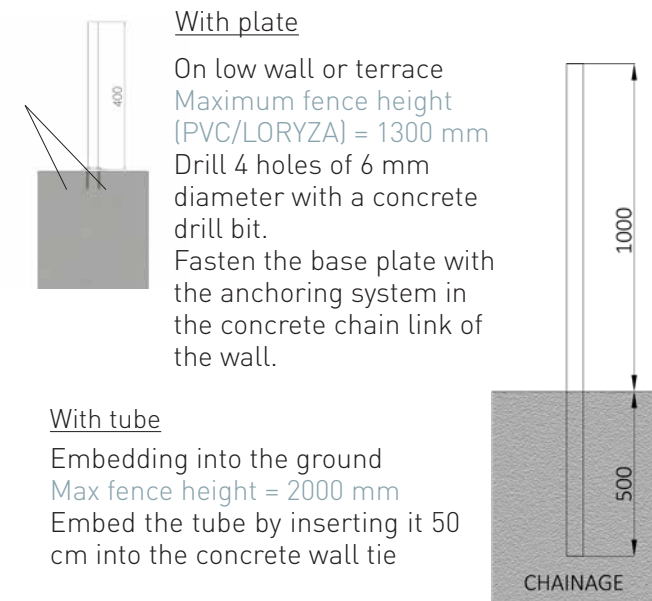

**STEP 5** Insert the posts

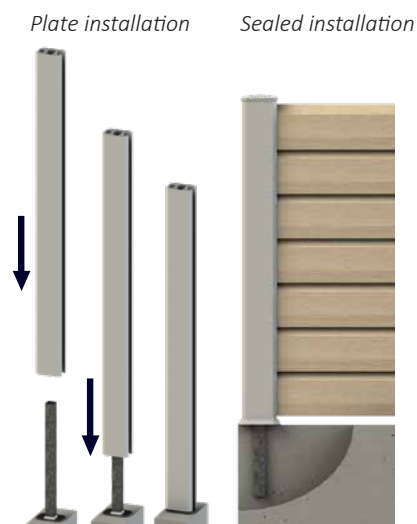

**STEP 7** Fix the posts on the supports (plate or tube to be embedded).

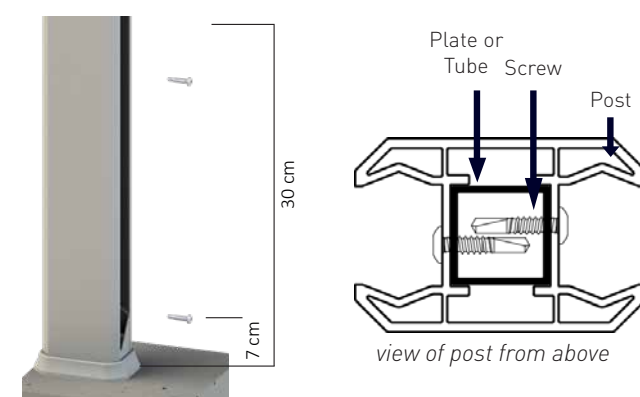

Screw 2 self-drilling screws on each side of the posts, respecting the heights indicated opposite (openwork version).

# Version pleine

**STEP 8** Fit the panels and inserts together in the chosen configuration



**STEP 9** Clip the finishing profile on the last panel



**STEP 10** Insert a U reducer into the post to compensate for the thickness of the panel (24 mm). Slide the panels as one into the posts, leaving a gap of 5 mm on each side.

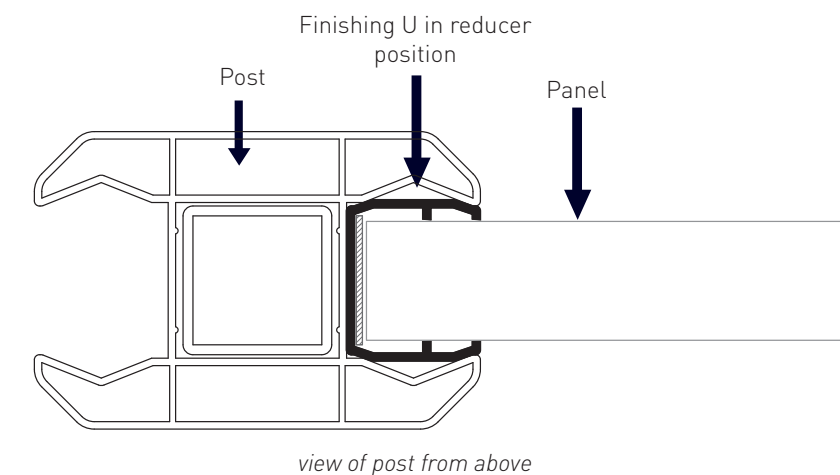

A reinforcement must be inserted in each panel for PVC or Loryza® fillings to avoid the «bimetal» effect.

**STEP 11** Glue and insert the caps onto the posts (PVC glue).



## Open-worked version privacy slat

**STEP 8** Slide the slat inside the posts leaving a 5 mm gap on each side.

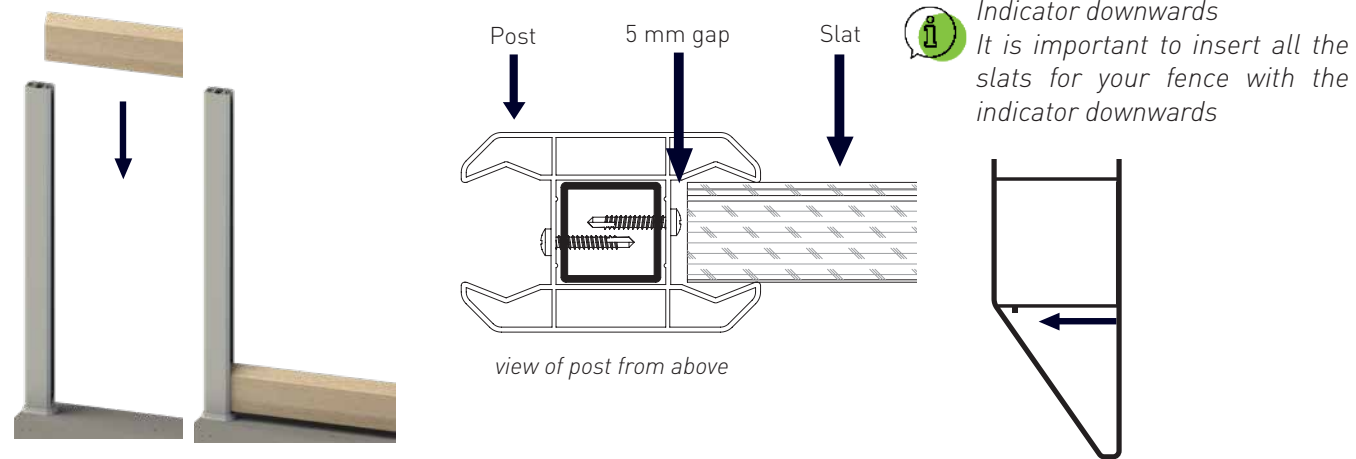

**i** A stiffener should be slid into each slat PVC or Loryza® fillers, to avoid the "bimetallic" effect.

**STEP 9** Insert the first intermediate spacers above each end of the slat.

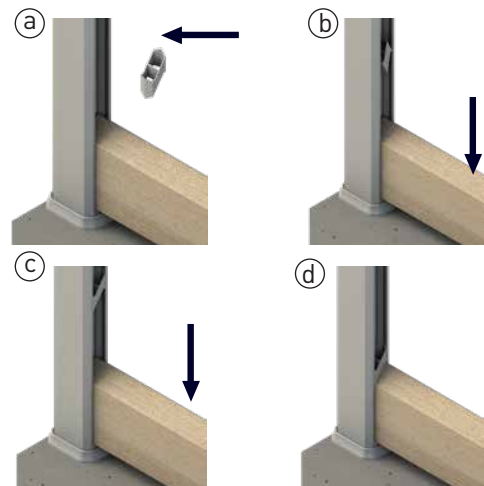

**STEP 10** Slide in the next slats, repeating steps 8 and 9, up to the desired height.

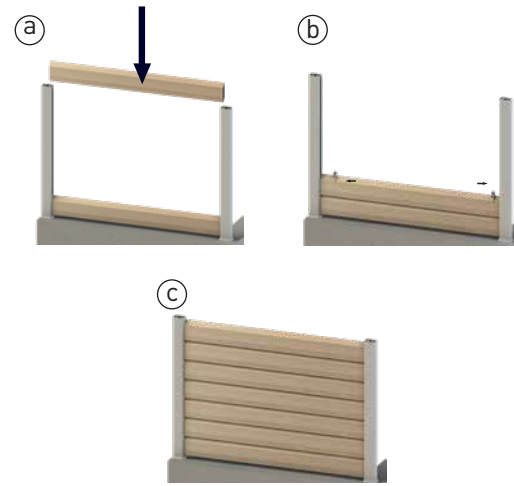

### DECOR PANEL OPTION :

Replace two privacy filler slats by one decor panel CL131. For the installation of your decor panel, please refer to the assembling principle on page 28.

Please do not forget the CL125 profiles.



**STEP 11** Insert the final spacers in the posts.

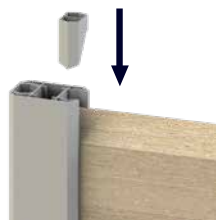

**STEP 12** Glue and insert the caps onto the posts (PVC glue).

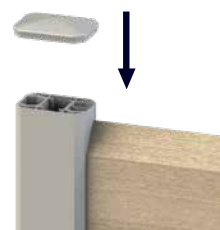

## Open-worked version Brizä slat

Scan the QR code to discover the assembly of brizä slat

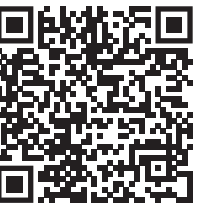

**STEP 8** Define the shape of your blade by inserting the CL125\_AL aluminum profiles on the CL126 or BS018 board or on the CL130 / CL131 decor panel.



**STEP 9** Slide the slat inside the posts leaving a 5 mm gap on each side

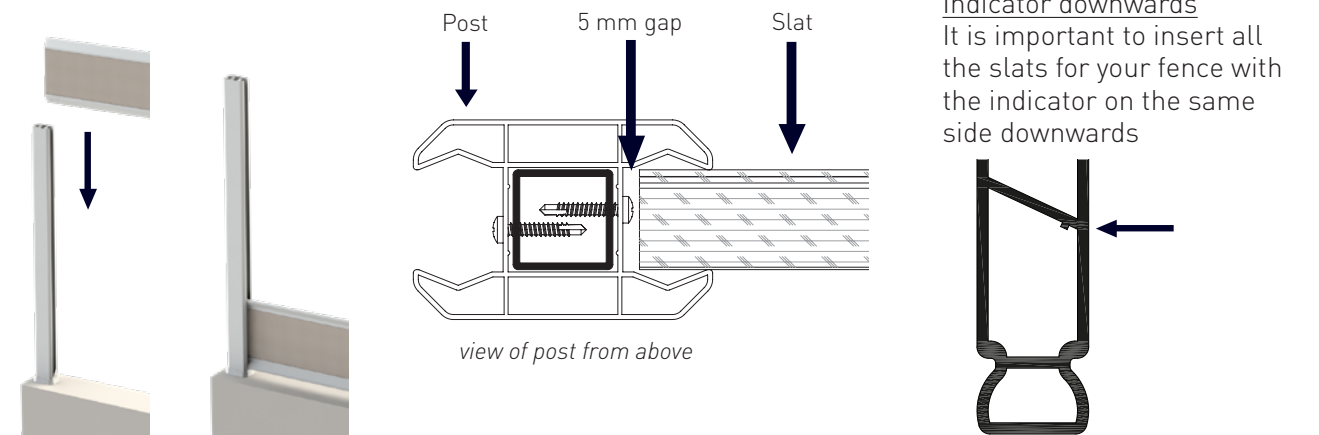

**STEP 10** Insert the first intermediate spacers above each end of the slat.

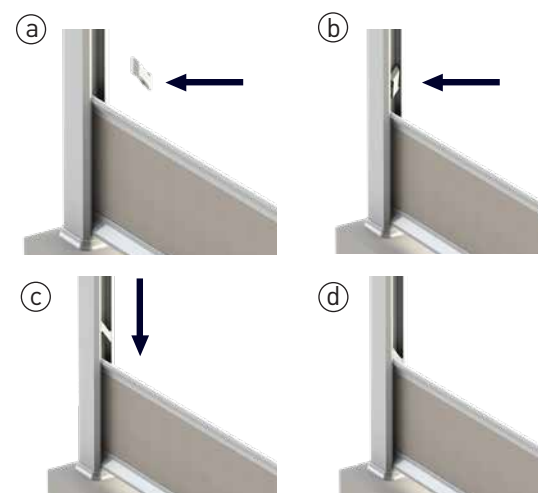

**STEP 11** Slide in the next slats, repeating steps 9 and 10, up to the desired height.

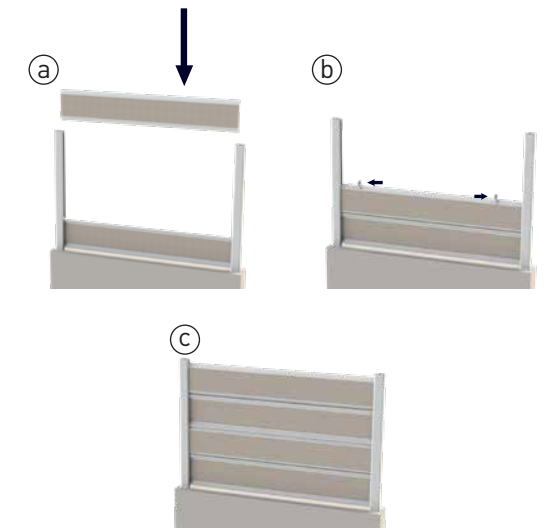

**STEP 12** Insert the final spacers in the posts.

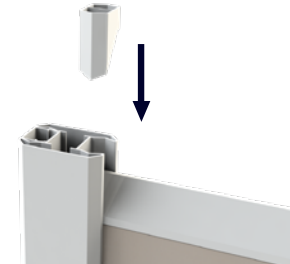

**STEP 13** Glue and insert the caps onto the posts (PVC glue).

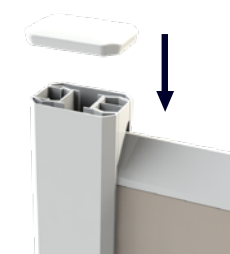



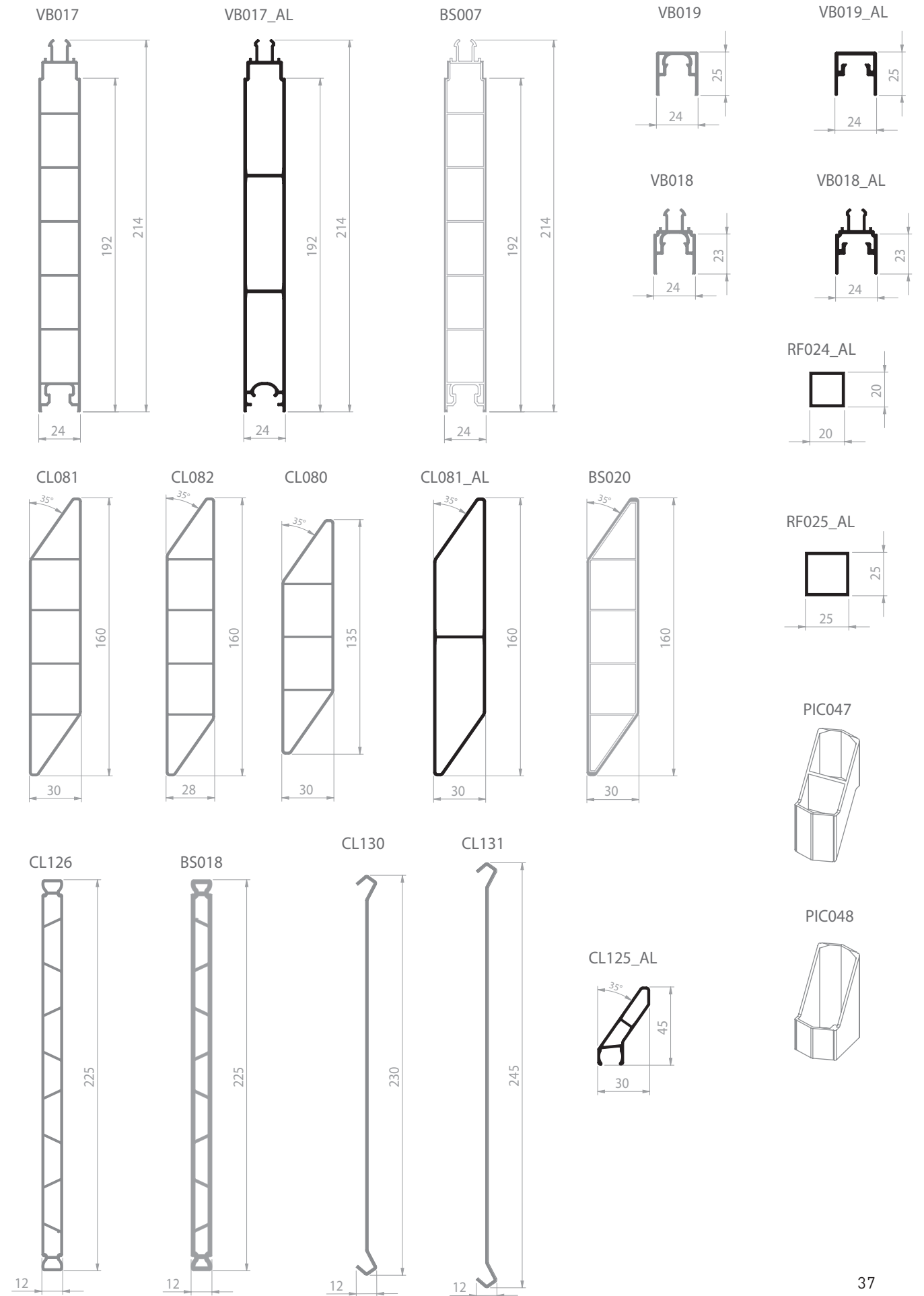
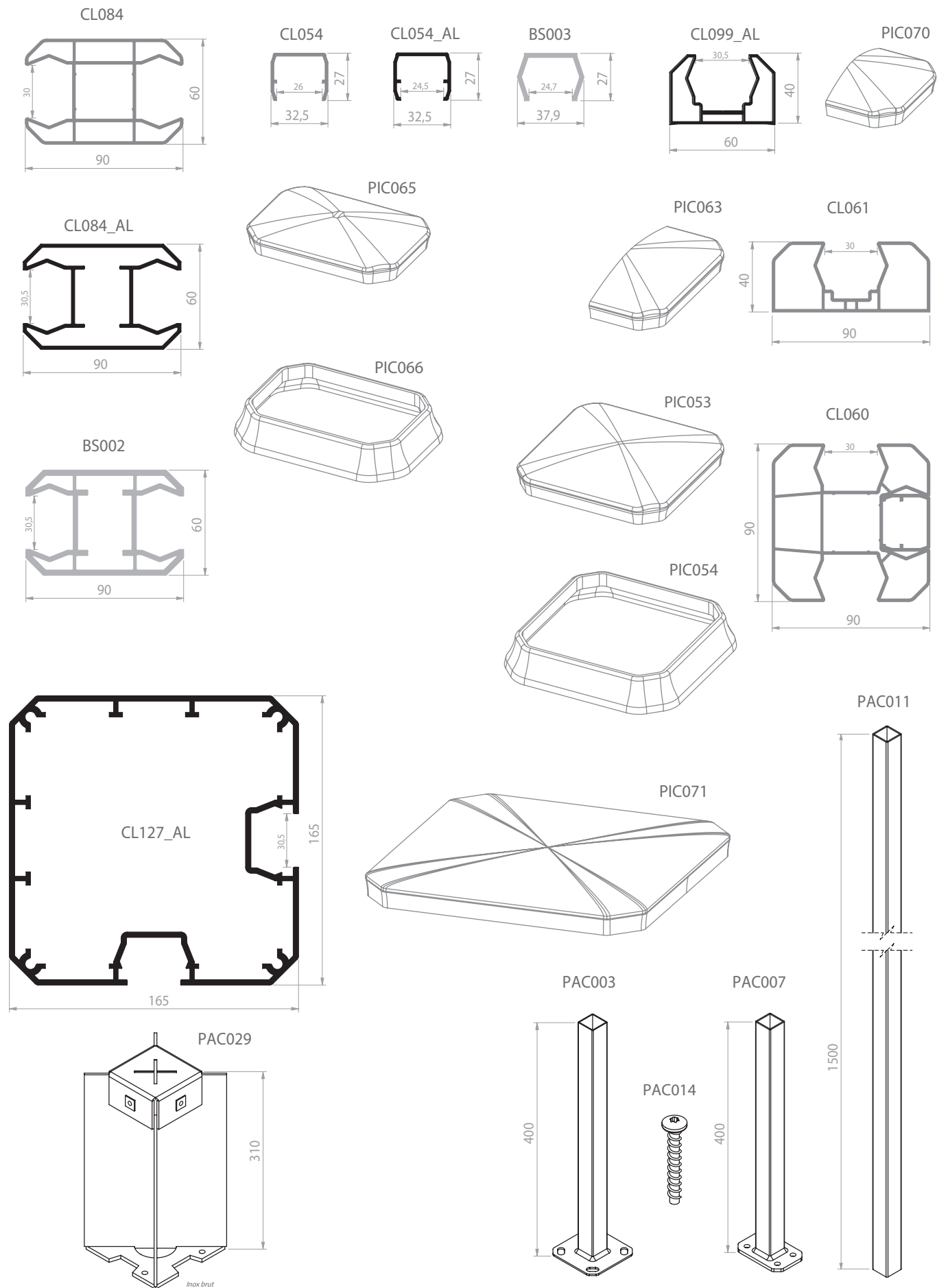

# SISTÄDEL

## THE MULTI-PURPOSE POST



Compatible with the Sistä and Sitadel range

### Its strong points

#### FEATURES

- > Designed to fix a gate, wicket and/or integrate a fence
- > A size of 165 x 165 mm allowing a good compromise between rigidity and aesthetics
- > Possibility to insert a reinforcement in the post for more rigidity

#### ORIGINALITY, DESIGN AND CUSTOMIZATION

- > Designed to integrate with the SISTÄ fence and SITADEL gate range, both in terms of design and technology
- > Customizable thanks to the SISTÄ fence profile available in many colors, including its new translucent version which allows the integration of an LED strip

#### EASY TO IMPLEMENT

- > Choice of: sealing or fixing on a plate



### Principle of installation with plate\* ON CONCRETE FOOTINGS

\*Recommendation for swing gates: not motorized and maximum size of the leaf - Ht x L : 1,50 m x 1,50 m

#### Step 1 :

Drill 4 holes of diameter 10 on the concrete support.

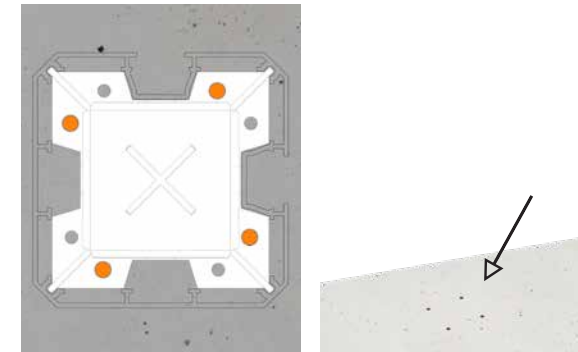

#### Step 2 :

Fix the plate with anchoring systems such as 10x100 dowels in the concrete chain link. To adjust its level and plumbness, use the M8 bolts to screw into the tapped holes.

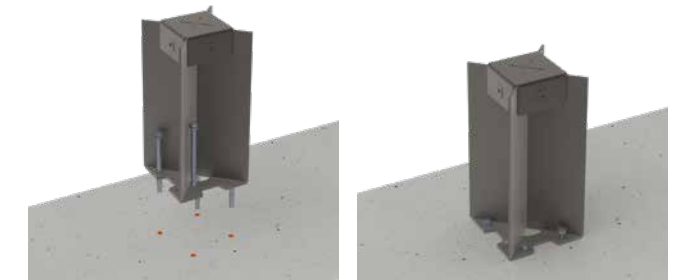

#### Step 3 :

Drill a 9 mm diameter hole in the center of each groove, 280 mm from the bottom of the post.

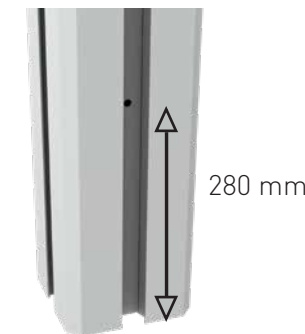

#### Step 4 :

Slide the post onto the plate.

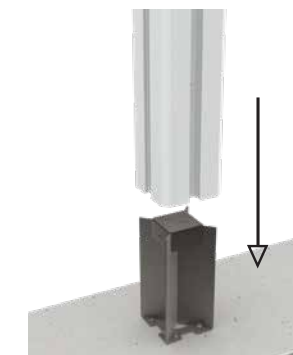

#### Step 5 :

Lock the post on the plate by screwing M8 bolts through the 2 holes.



### Sealing principle

ON THE GROUND

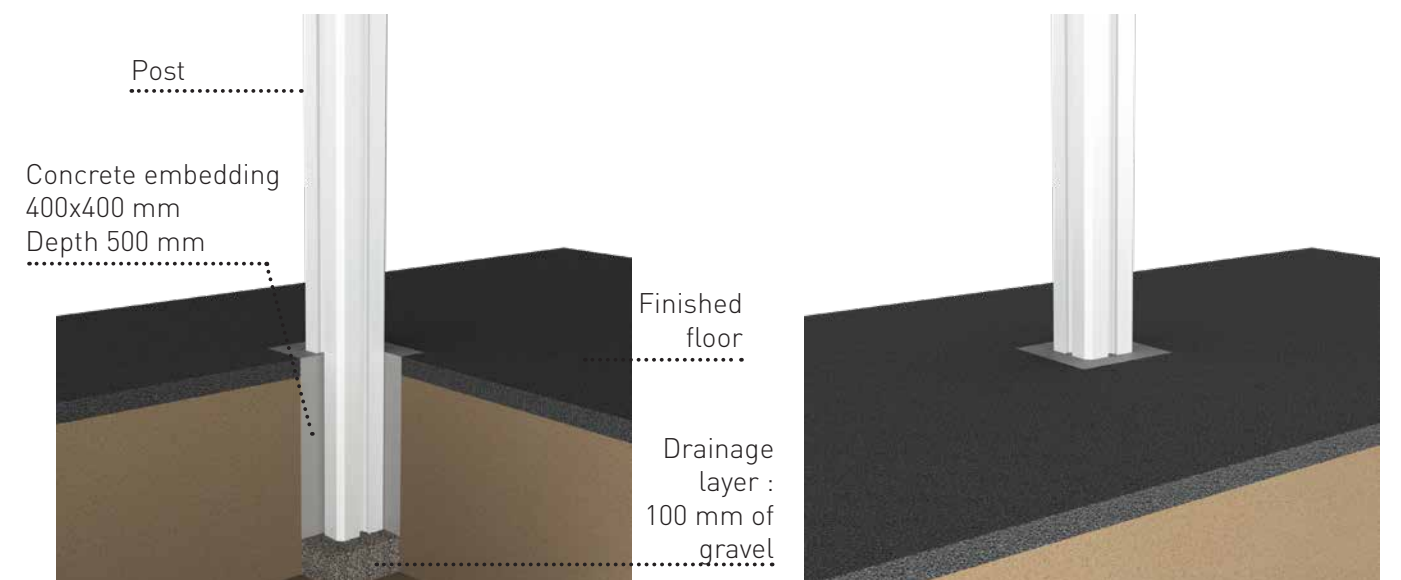



## Article Coding

More information on the references in the prestige and trend collections - SISTÄ and SITADEL.  
Available in lacquered aluminum and plated aluminum versions.



**CL127\_AL**  
ALU POST 165X165



**PAC029**  
SUPPORT PLATE FOR POST CL127\_AL



**CL054**  
U GROOVE COVER



**PIC071**  
POST END CL127\_AL

## Attachments for gate accessories

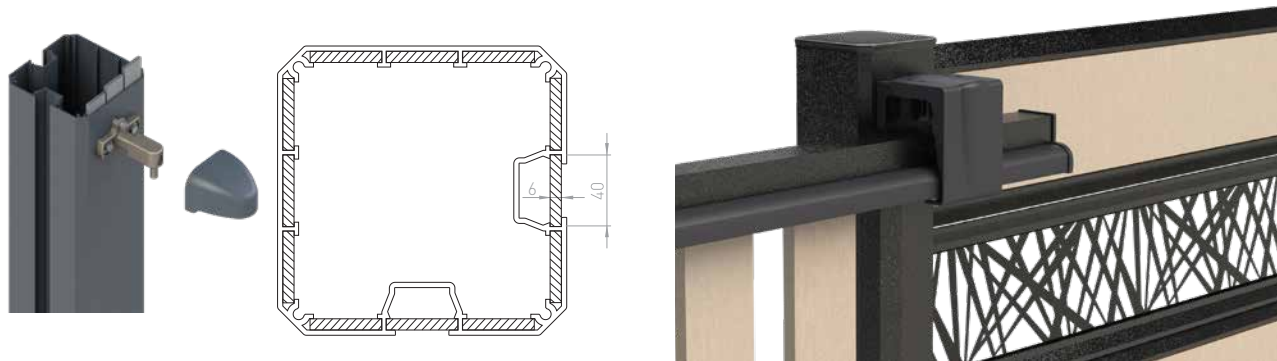

## Integration of the different fences



Filling in of the windscreen slat



BRIZÄ filling



Solid panel filling

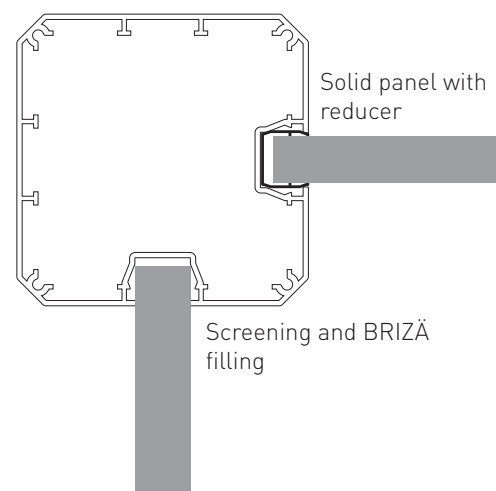

Solid panel with reducer

Screening and BRIZÄ filling

## PRODUITS D'ENTRETIEN ET STYLOS DE FINITION

### ARTICLE POUR LA MACHINE COMALL



**ZL\_OLX20000**  
BOMBE DE LUBRIFIANT COMALL  
Lubrification des outils de poinçonnage de la Comall

### PRODUITS DE NETTOYAGE



**PLAX\_RENO\_NETTOYANT**  
NETTOYANT RENOLIT EXOFOIL  
POUR PRODUIT PLAXÉ  
1L



**ZL\_SPARTEX**  
DÉGRAISSANT POUR NETTOYAGE  
(NETTOYANT LORYZA)

### STYLOS DE FINITION



**ZSTY\_CD2178001**  
STYLO RETOUCHE  
PLAXÉ CHÊNE DORÉ



**ZSTY\_GRA701605**  
STYLO RETOUCHE  
PLAXÉ GRIS ANTHRACITE



**ZSTY\_AT3241**  
STYLO RETOUCHE  
PLAXÉ ANTEAK



**ZSTY\_BM6030**  
STYLO RETOUCHE  
BLANC MATTEX



**ZSTY\_GM6066**  
STYLO RETOUCHE  
GRIS MATTEX



**ZSTY\_GQ6047**  
STYLO RETOUCHE  
GRIS QUARTZ



**ZSTY\_JB6062**  
STYLO RETOUCHE  
NOIR MATTEX



**ZSTY\_PO903A**  
STYLO RETOUCHE  
PEPPER OAK



**ZSTY\_SA3002**  
STYLO RETOUCHE  
PLAXÉ SHEFFIELD OAK ALPINE



**ZSTY\_SC3003**  
STYLO RETOUCHE  
PLAXÉ SHEFFIELD OAK  
CONCRÈTE

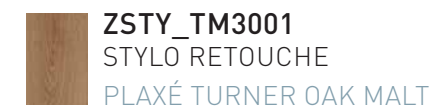

**ZSTY\_TM3001**  
STYLO RETOUCHE  
PLAXÉ TURNER OAK MALT

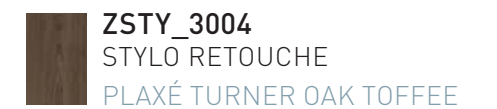

**ZSTY\_3004**  
STYLO RETOUCHE  
PLAXÉ TURNER OAK TOFFEE

### NUANCIER

**ZN\_PLAXE\_OUTDOOR**  
NUANCIER DES FILMS DE PLAXAGE  
DE LA GAMME OUTDOOR





# SITADEL

## NOUVEAUTÉ

### COLLECTION PRESTIGE

p.46



ALU plaxé

### COLLECTION TENDANCE

p.50



Loryza®, ALU ou PVC

## The colors

Find out more about the color guarantee chart from a sales representative.

### ALUMINIUM - LACQUERED FINISHES



### PVC - TINTED FINISHES



COLORIS GUARANTEED  
10  
YEARS

### LORYZA®



COLORIS GUARANTEED  
2  
YEARS

### ALU & PVC PLAXED FINISHES

COLORIS GUARANTEED  
15  
YEARS

Frame, structure, post and accessory profiles are the only profiles available in plated ALU.

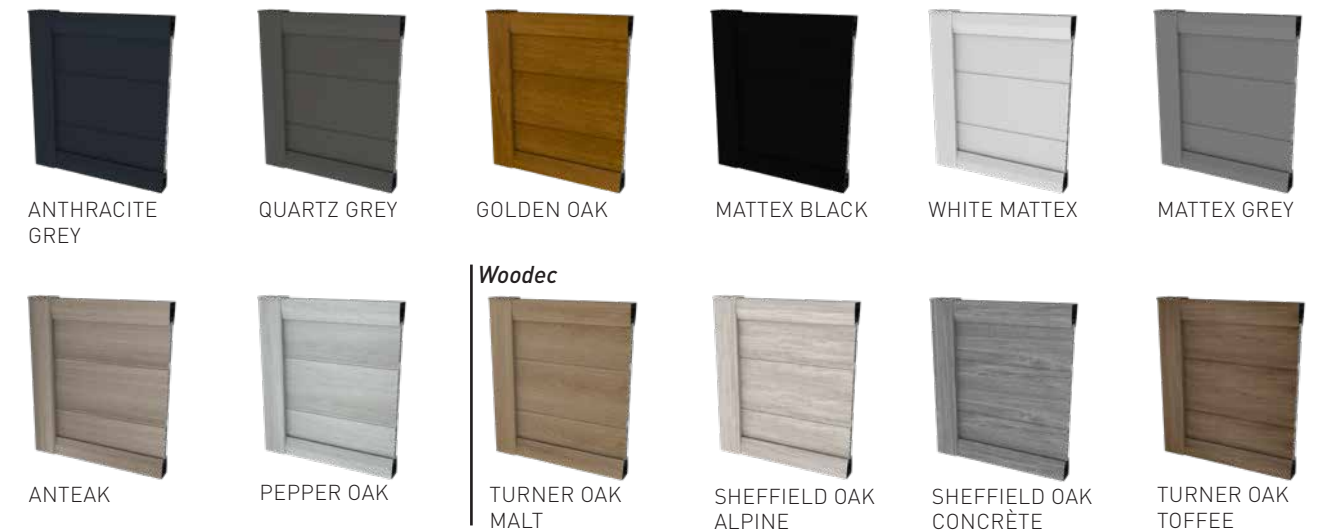

Woodec



# OUR MACHINES

## > COMALL PUNCHING MACHINE



### Machining - Tendance & Prestige collection

Geplast decided to rely on the expertise of Comall, a company specialized in the supply of machines dedicated to the punching and machining of aluminum parts.

If your company does not have the necessary tools to carry out these machining operations, you can simply rent the Comall machine from Geplast. The machine is adjusted and training is provided by Geplast.

## > COPY MILLING MACHINE

The copy milling machine allows you to machine the accessories of the Tendance and Prestige collections. The use of this machine allows you to facilitate your work and save time. Geplast provides you with the 3D elements and the copying plates (several copying plates are available).



Copy plate



Machining of an ALU post

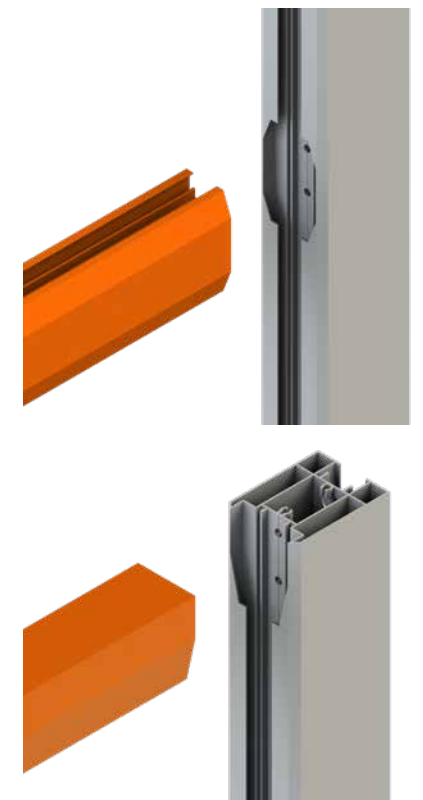

*Do not hesitate to contact your sales representative for more information.*



SITADEL

# PRESTIGE COLLECTION

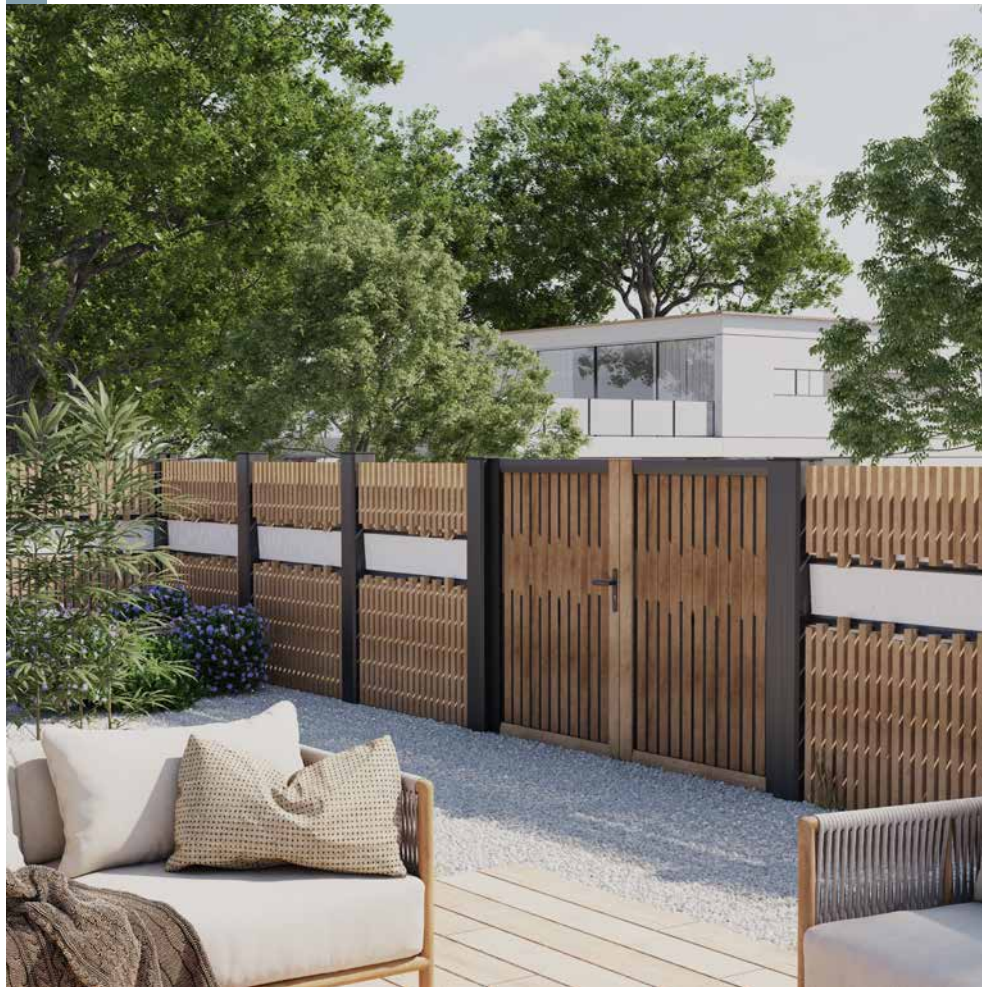

*Prestige Collection: plaxed or Loryza® finishes.*

## ALU plaxed



Prestige is the very first gate collection to offer all its structural profiles and accessories in a plaxed ALU finish.

It offers a wide choice of plaxed finishes with 12 films that can be combined according to your desires.

Discover the 7 «wood» look finishes, a unique offer on the outdoor market.





## The profiles Prestige Collection

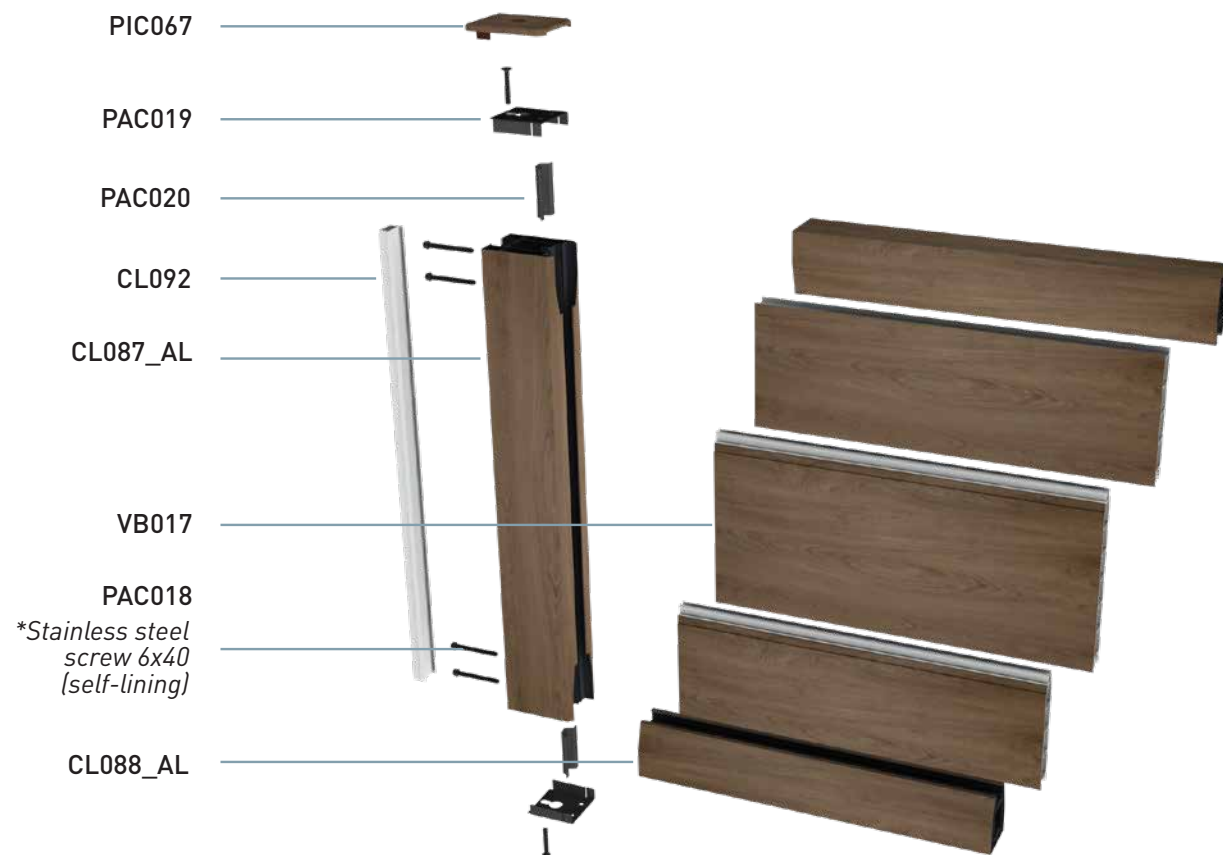

\*Geplast does not sell stainless steel screws.

## Article coding

Discover all the colors on pages 42-43 and on request.

### > STRUCTURE

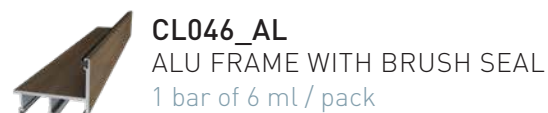

**CL046\_AL**  
ALU FRAME WITH BRUSH SEAL  
1 bar of 6 ml / pack



**CL087\_AL**  
AMOUNT 68x90MM  
1 bar of 6 ml / pack



**CL088\_AL**  
TRAVERSE 54x72MM  
2 bars of 6 ml / pack

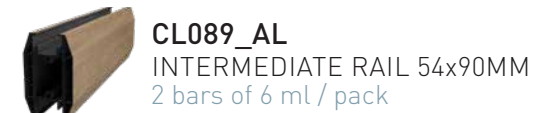

**CL089\_AL**  
INTERMEDIATE RAIL 54x90MM  
2 bars of 6 ml / pack

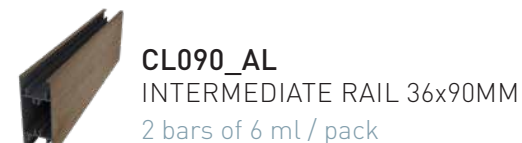

**CL090\_AL**  
INTERMEDIATE RAIL 36x90MM  
2 bars of 6 ml / pack



**CL092**  
FINISHING PROFILE  
2 bars of 6 ml / pack



**CL127\_AL**  
POST 165X165MM  
1 bar of 2,60 ml / pack



**CL128**  
BEATING RECEPTION PROFILE  
2 bars of 6 ml / pack

### > UNTREATED ALU STIFFENERS

We recommend the use of reinforcements in dark-colored PVC and Loryza® slats and panels and Loryza® panels from 1.20 m in length.

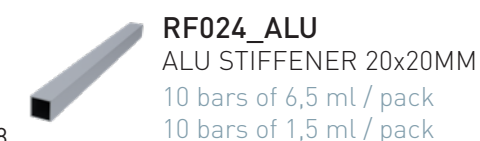

**RF024\_ALU**  
ALU STIFFENER 20x20MM  
10 bars of 6,5 ml / pack  
10 bars of 1,5 ml / pack

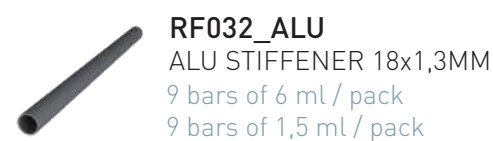

**RF032\_ALU**  
ALU STIFFENER 18x1,3MM  
9 bars of 6 ml / pack  
9 bars of 1,5 ml / pack

### > ACCESSOIRES



**PIC067**  
FLUSH FITTING FOR UPRIGHT  
10 pieces / bag



**PIC068**  
RUBBER FOR UPRIGHT  
10 pieces / bag



**PIC071**  
POST END 165x165MM  
Piece  
5 pieces / bag



**PIC072**  
WINDSCREEN SPACERS  
50 pairs / bag



**PIC075**  
RECEIVING PROFILE TIP  
10 pieces / bag

### > PVC FILLER PANELS



**CL028**  
PRIVACY FENCE 160x24MM  
5 bars of 6 ml / pack



**CL029**  
BOARD 120x24MM  
5 bars of 6 ml / pack



**CL094**  
BAR 80x24MM  
5 bars of 6 ml / pack



**CL098**  
BOARD 80x24MM  
5 bars of 6 ml / pack

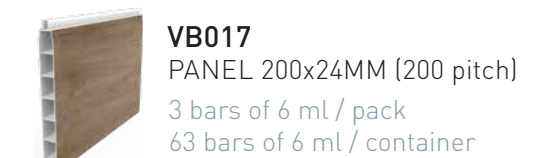

**VB017**  
PANEL 200x24MM (200 pitch)  
3 bars of 6 ml / pack  
63 bars of 6 ml / container

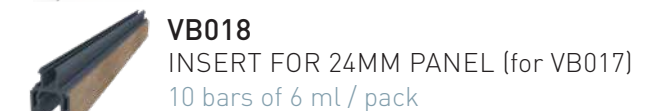

**VB018**  
INSERT FOR 24MM PANEL (for VB017)  
10 bars of 6 ml / pack

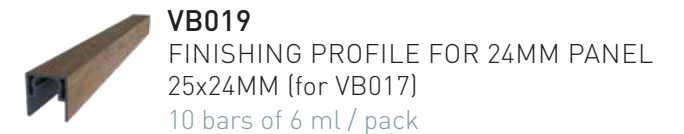

**VB019**  
FINISHING PROFILE FOR 24MM PANEL  
25x24MM (for VB017)  
10 bars of 6 ml / pack

### > LORYZA® FILLER PANELS

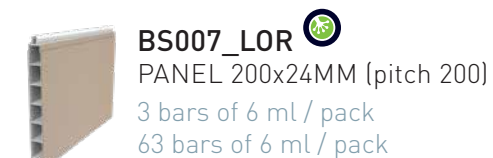

**BS007\_LOR**  
PANEL 200x24MM (pitch 200)  
3 bars of 6 ml / pack  
63 bars of 6 ml / pack



**BS008\_LOR**  
INTERBAR 20x24MM  
5 bars of 6 ml / pack



**BS009\_LOR**  
BAR 80x24MM  
5 bars of 6 ml / pack



**BS019\_LOR**  
PRIVACY FENCE 160x24MM  
3 bars of 6 ml / pack  
80 bars of 6 ml / pack

### > STEEL FASTENINGS



**PAC018**  
CONNECTING SCREW  
100 pieces / box



**PAC019\_INOX**  
PIVOT PIECE  
20 pieces / pack



**PAC020**  
COUNTER SCREWING PLATE  
10 pieces / bag



**PAC029\_INOX**  
ALU POST SUPPORT PLATE 165x165MM  
Piece

# SITADEL TENDANCE COLLECTION



*Trend Collection: stained, plaxed, lacquered and Loryza® finishes*

## The mix of materials





# The profiles Trendy collection

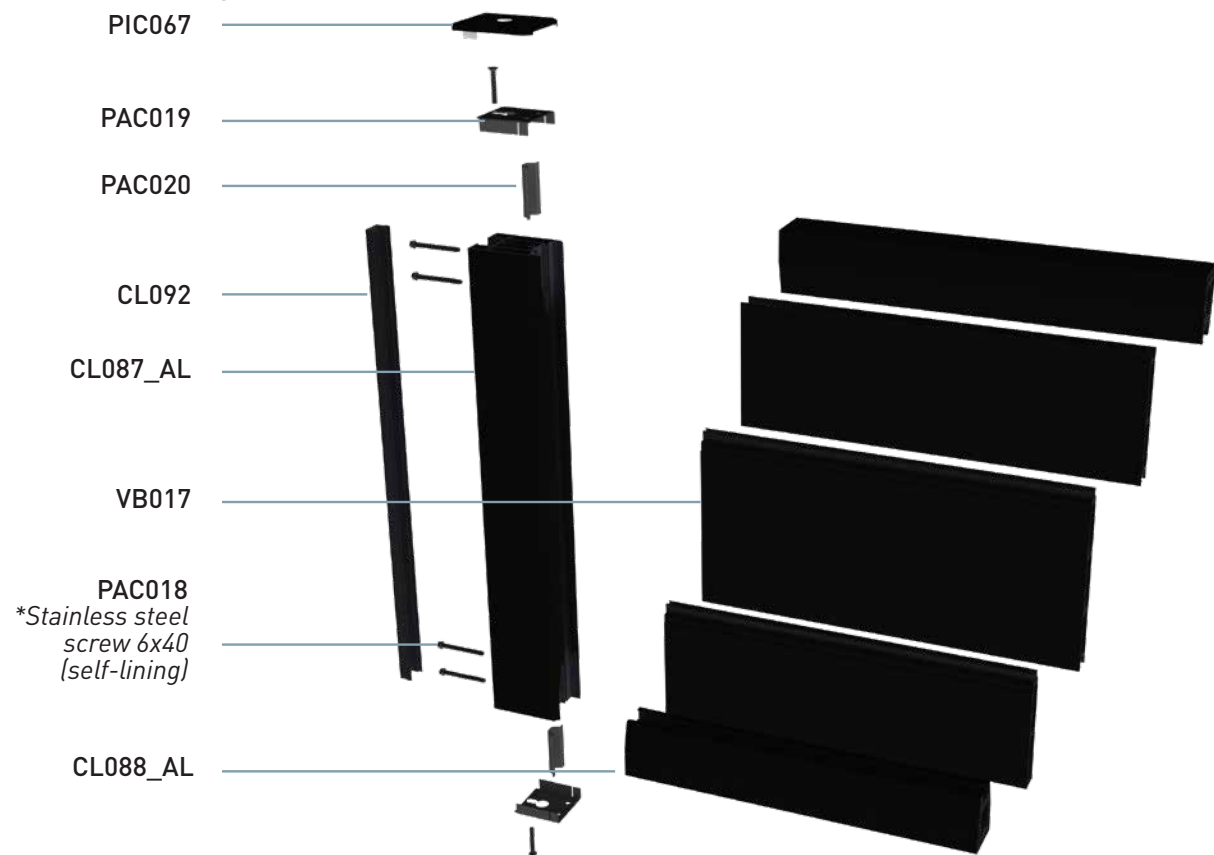

\*Geplast does not sell stainless steel screws.

## Article coding

Discover all the colors on pages 42-43 and on request.

### STRUCTURE

-  **CL046\_AL**  
ALU FRAME WITH BRUSH SEAL  
2 bars of 6 ml / pack
-  **CL087\_AL**  
AMOUNT 68x90MM  
1 bar of 6 ml / pack
-  **CL088\_AL**  
TRAVERSE 54x72MM  
2 bars of 6 ml / pack
-  **CL089\_AL**  
INTERMEDIATE RAIL 54x90MM  
2 bars of 6 ml / pack

-  **CL090\_AL**  
INTERMEDIATE RAIL 36x90MM  
2 bars of 6 ml / pack
-  **CL092\_AL**  
FINISHING PROFILE  
2 bars of 6 ml / pack
-  **CL127\_AL**  
POST 165X165MM  
1 bar of 2,60 ml / pack
-  **CL128**  
PVC FLAP RECEIVER PROFILE  
2 bars of 6 ml / pack

### UNTREATED ALU STIFFENERS

We recommend the use of reinforcements in dark-colored PVC and Loryza® slats and panels and Loryza® panels from 1.20 m in length.

-  **RF024\_ALU**  
ALU STIFFENER 20x20MM  
10 bars of 6,5 ml / pack  
10 bars of 1,5 ml / pack
-  **RF032\_ALU**  
ALU STIFFENER 18x1,3MM  
9 bars of 6 ml / pack  
9 bars of 1,5 ml / pack

### ACCESSOIRES

-  **PIC067**  
FLUSH FITTING FOR UPRIGHT  
Piece  
10 pieces / bag
-  **PIC068**  
RUBBER FOR UPRIGHT  
Piece  
10 pieces / bag









-  **PIC071**  
POST END 165x165MM  
Piece  
5 pieces / bag
-  **PIC075**  
RECEIVING PROFILE TIP  
10 pieces / bag
-  **PIC072**  
WINDSCREEN SPACERS  
50 pairs / bag

### FILLER PANELS

-  **CL028 - CL028\_AL**  
PRIVACY FENCE 160x24MM  
ALU 2 bars of 6 ml / pack  
PVC 5 bars of 6 ml / pack
-  **CL029 - CL029\_AL**  
BOARD 120x24MM  
ALU 2 bars of 6 ml / pack  
PVC 5 bars of 6 ml / pack
-  **CL094 - CL094\_AL**  
CHAMFERED BAR  
ALU 2 bars of 6 ml / pack  
PVC 5 bars of 6 ml / pack
-  **CL098 - CL098\_AL**  
BOARD 80x24MM  
ALU 2 bars of 6 ml / pack  
PVC 5 bars of 6 ml / pack

-  **VB017 - VB017\_AL**  
PANEL 200x24MM  
ALU Bar of 6 ml  
PVC 3 bars of 6 ml / pack  
63 bars of 6 ml / pack
-  **VB018 - VB018\_AL**  
INSERT FOR 24MM PANEL (for VB017)  
ALU 12 bars of 6 ml / pack  
PVC 10 bars of 6 ml / pack
-  **VB019 - VB019\_AL**  
FINISHING PROFILE FOR 24MM (for VB017)  
ALU 12 bars of 6 ml / pack  
PVC 10 bars of 6 ml / pack

### LORYZA® FILLER PANELS

-  **BS007\_LOR**   
PANEL 200x24MM (pitch 200)  
3 bars of 6 ml / paquet  
63 bars of 6 ml / container
-  **BS008\_LOR**   
INTERBAR 20x24MM  
5 bars of 6 ml / paquet
-  **BS009\_LOR**   
BAR 80x24MM  
5 bars of 6 ml / paquet
-  **BS019\_LOR**   
PRIVACY FENCE 160x24MM  
3 bars of 6 ml / paquet  
80 bars of 6 ml / container

### STEEL FASTENINGS

-  **PAC018**  
CONNECTING SCREW  
100 pieces / box
-  **PAC019\_INOX**  
PIVOT PIECE  
20 pieces / pack
-  **PAC020**  
COUNTER SCREWING PLATE  
10 pieces / bag
-  **PAC029\_INOX**  
ALU POST SUPPORT PLATE 165x165MM  
Piece

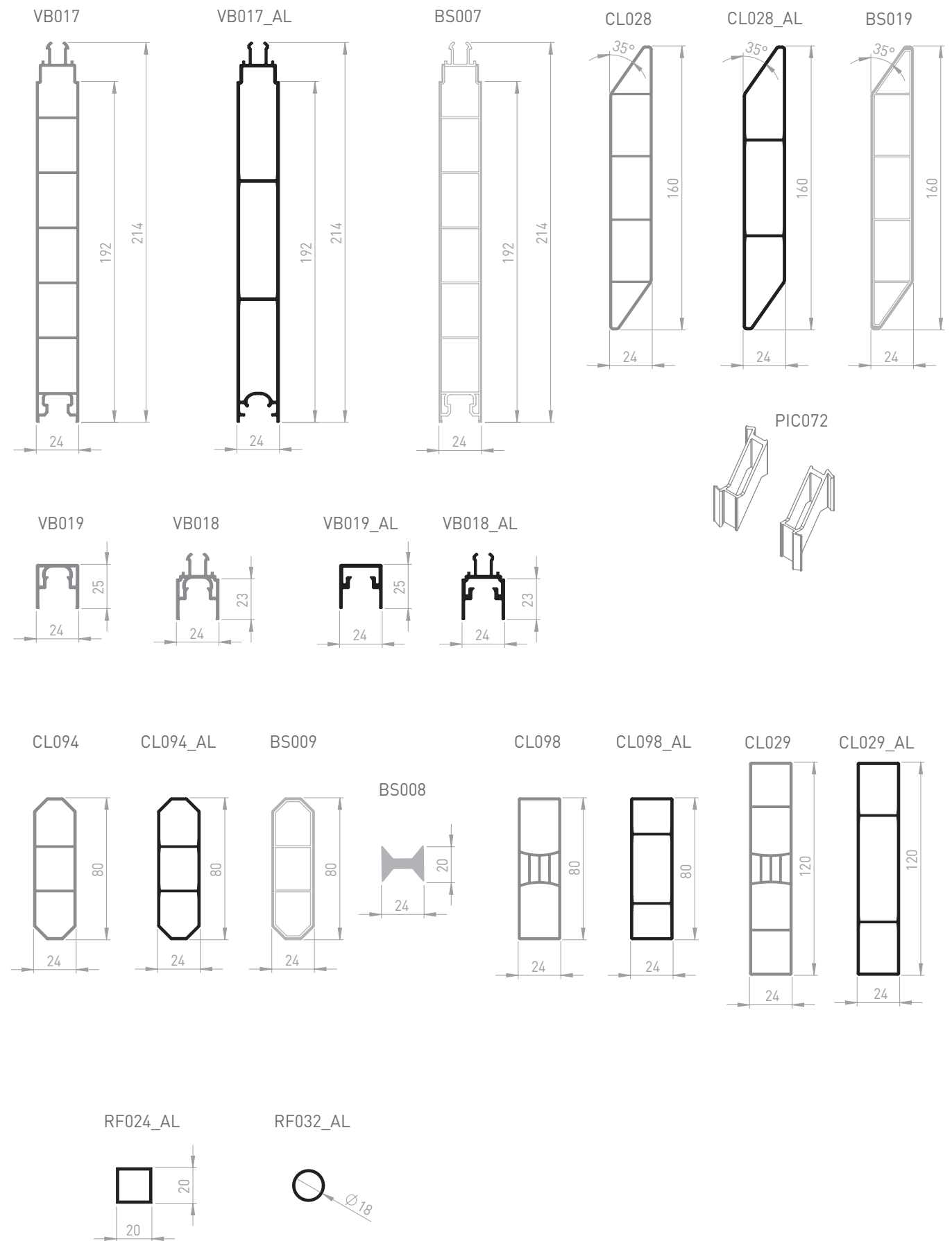
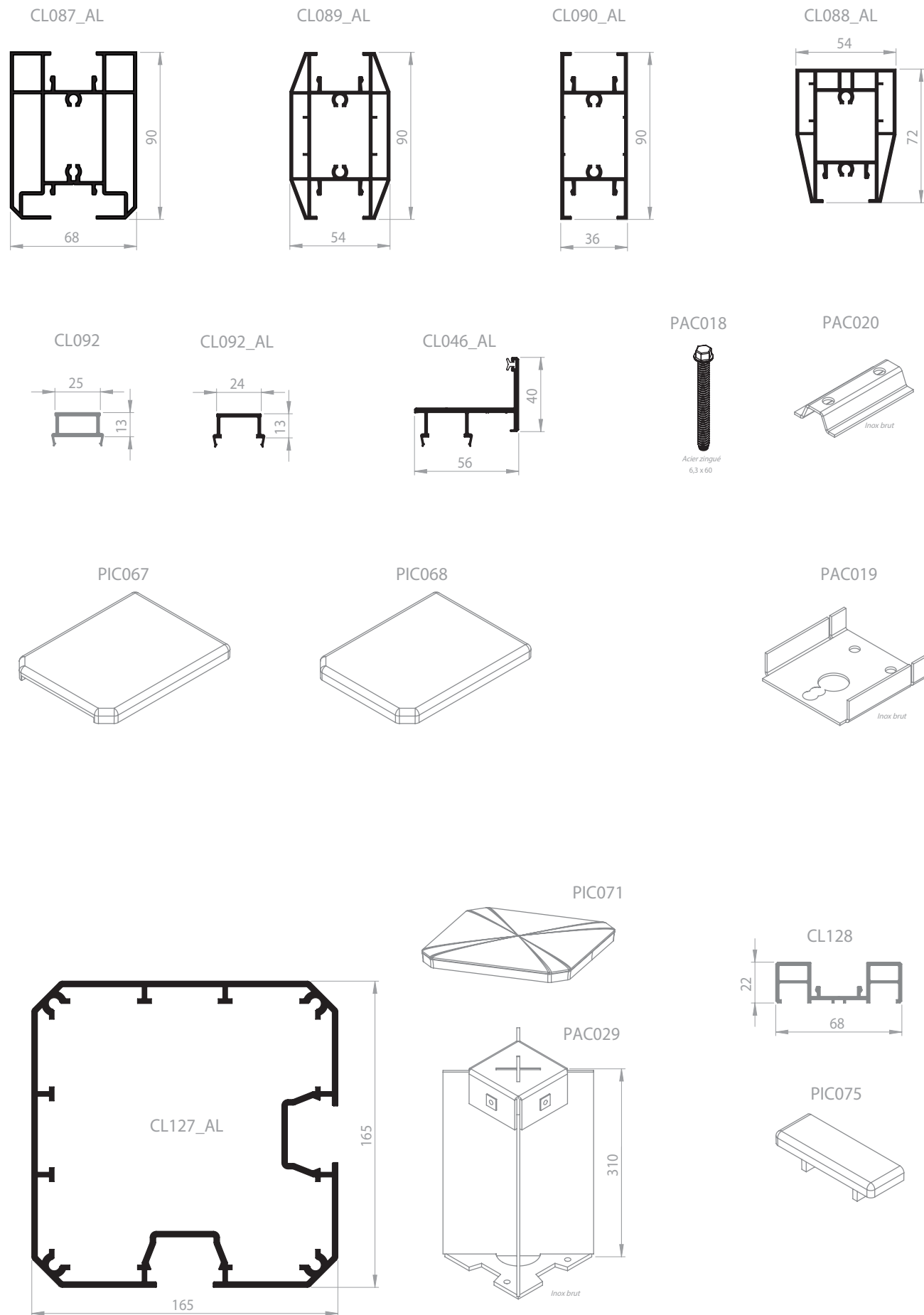





# GATES & FENCES SURFACE-MOUNTED FRAME

## The colours

Find out the colour guarantee table from a sales representative.

### FINITIONS TEINTÉES MASSE

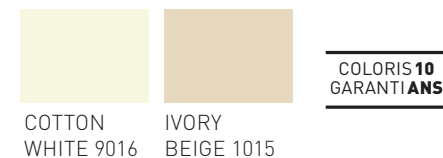

### FINITIONS PLAXÉES



### FINITIONS LAQUÉES



## SUMMARY

- |    |                    |    |                           |
|----|--------------------|----|---------------------------|
| 62 | Boards             | 66 | Sheathing                 |
| 63 | Curved boards      | 67 | The posts                 |
| 64 | The bars           | 68 | Panels and reinforcements |
| 65 | Cassette mouldings | 70 | The finishing u's         |
| 65 | The beats          | 70 | The filling blades        |

## BOARDS

### CL001 - 120x28 - R1

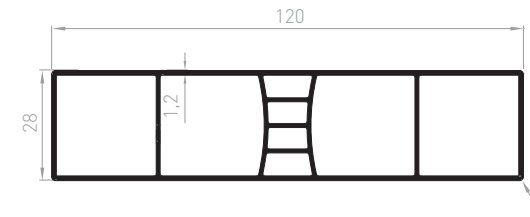

**PACK SIZES**  
5 bars of 6ml / pack  
98 bars of 6ml / container

#### Matching tips

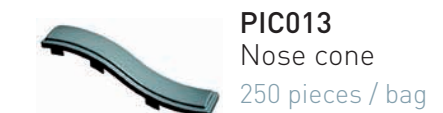
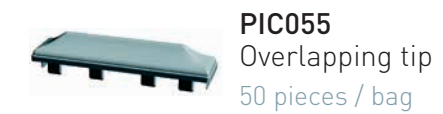

### CL002 - 120x28 - R5

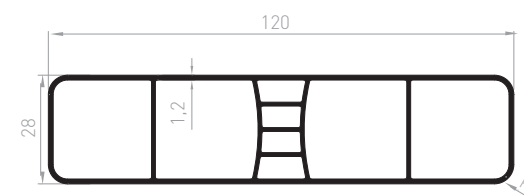

**PACK SIZES**  
5 bars of 6ml / pack  
98 bars of 6ml / container

#### Matching tips

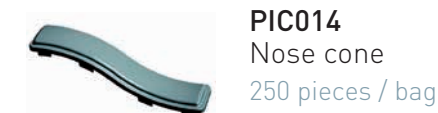

### CL017- 160x28 - R2.5

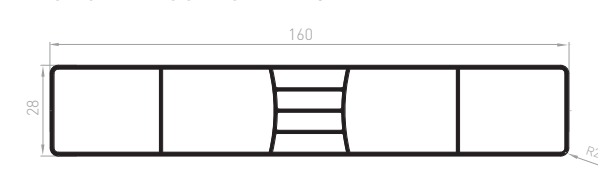

**PACK SIZES**  
5 bars of 6ml / pack  
75 bars of 6ml / container

#### Matching tips



## CURVED BOARDS

CL003 - 120x28 - R1 for hanger only

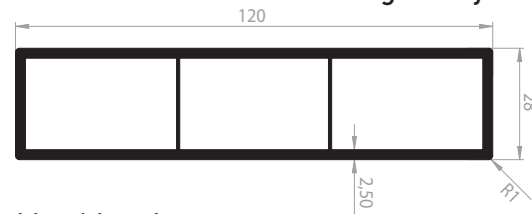

PACK SIZES  
Piece

Matching tips



**PIC010**  
R1 flat spigot  
50 pieces / bag

**CL201**  
CDG L2000



**CL202**  
CDG L1500

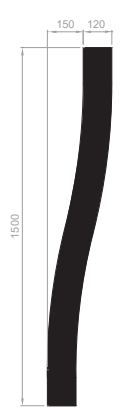

**CL203**  
CDG L1000



**CL204**  
BOMBÉ L2000

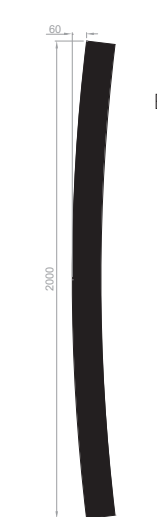

**CL205**  
BOMBÉ L1500

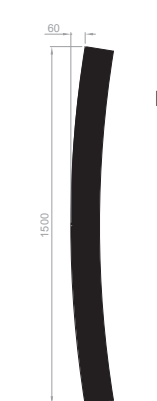

**CL206**  
BOMBÉ L1000

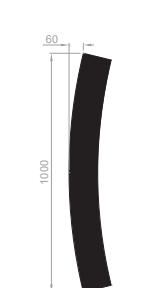

CL004 - Board 120x28 - R5 for hanger only

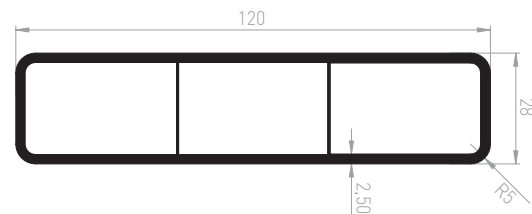

PACK SIZES  
Piece

Matching tips



**PIC011**  
Flat tip R5  
50 pieces / bag

**CL207**  
CDG L2000



**CL208**  
CDG L1500

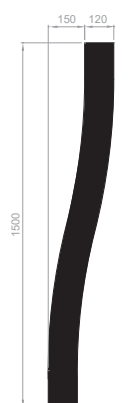

**CL209**  
CDG L1000



**CL210**  
BOMBÉ L2000

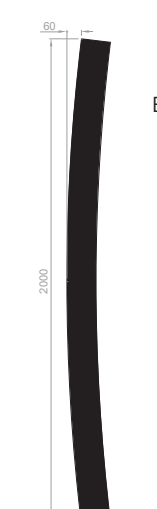

**CL211**  
BOMBÉ L1500

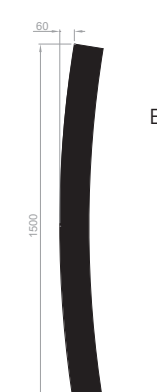

**CL212**  
BOMBÉ L1000

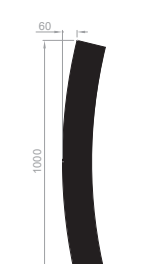

## THE BARS

CL029 - Bar 120x24MM

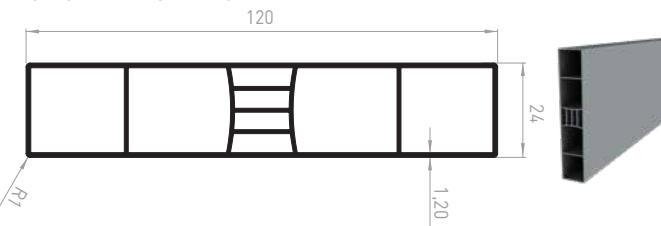

PACK SIZES  
5 bars of 6 ml / pack

CL047 - Bar 80x20MM - R1

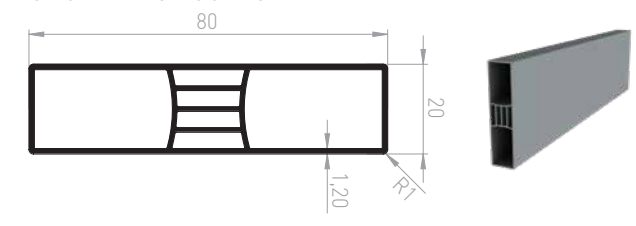

PACK SIZES  
5 bars of 6 ml / pack  
200 bars of 6 ml / container

CL098 - Bar 80x24MM - R1

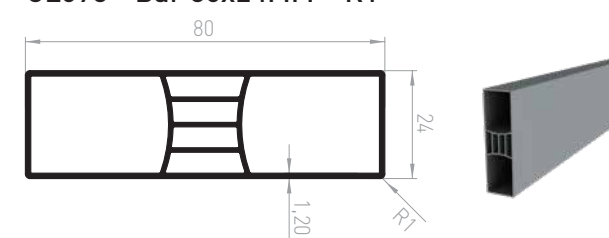

PACK SIZES  
5 bars de 6 ml / pack

CL064 - Bar 80x28MM - R1

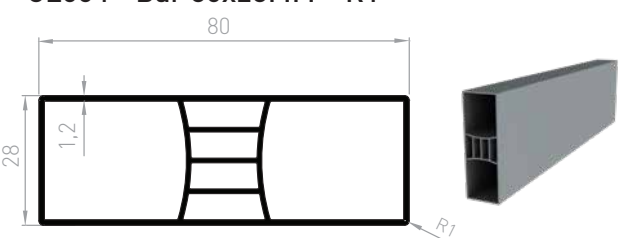

PACK SIZES  
5 bars of 6 ml / pack

Matching tips



**PIC057**  
Flat tip  
lacquered  
Pieces  
50 pieces / bag



**PIC058**  
Overlapping moulded end cap  
lacquered  
Pieces  
50 pieces / bag

CL005 - Bar 80x28MM - R5

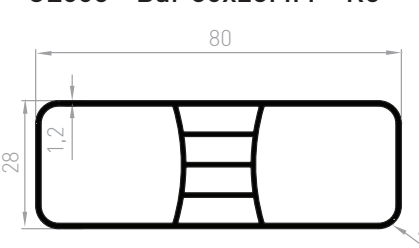

PACK SIZES  
5 bars de 6 ml / pack  
150 bars of 6 ml / container

Matching tips



**PIC019**  
Flat tip  
250 pièces / sachet



**PIC020**  
Overlapping moulded end cap  
lacquered  
Pieces  
250 pieces / bag



## > CASSETTE MOULDINGS

CL010 - Filling moulding 24/28mm

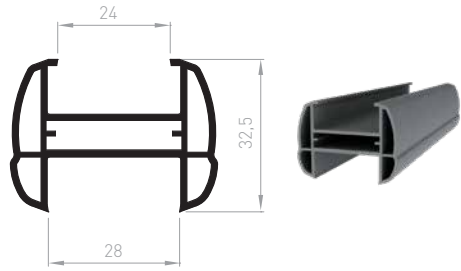

### PACK SIZES

10 bars of 6 ml / pack  
250 bars of 6 ml / container

CL011 - Mortise moulding 28mm

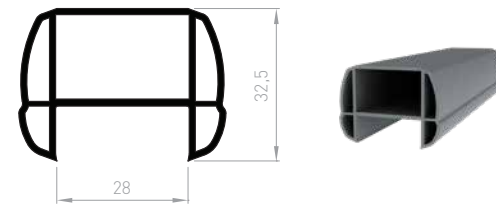

### PACK SIZES

10 bars of 6 ml / pack  
250 bars of 6 ml / container

## > THE BEATS

CL041 - Moulding 24MM

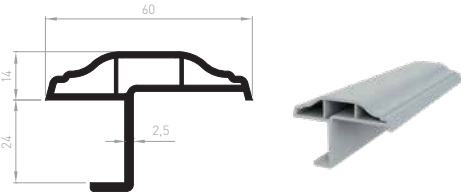

### PACK SIZES

5 bars of 6 ml / pack  
300 bars of 6 ml / container

CL042 - Moulding 24MM

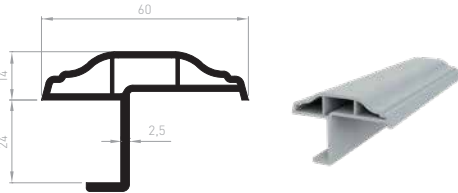

### PACK SIZES

5 bars of 6 ml / pack  
300 bars of 6 ml / container

CL066 - Moulding 28MM

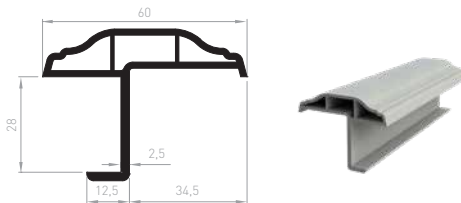

### PACK SIZES

5 bars of 6 ml / pack  
300 bars of 6 ml / container

CL043 - Moulding - R5

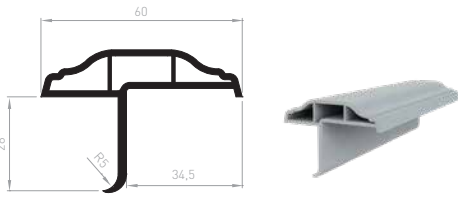

### PACK SIZES

5 bars of 6 ml / pack

The tip for all beats



**PIC033**  
Embout couvre-joint  
50 pieces / bag

## > SHEATHING

CL030 - Tube sheathing 40x40MM

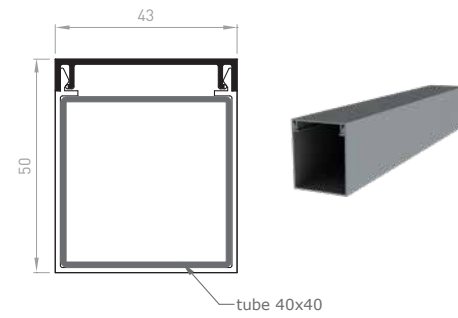

### PACK SIZES

6 bars of 6ml / pack  
150 bars of 6ml / container

Matching tips



**PIC017**  
Flat end 40x40MM closed  
50 pieces / bag



**PIC018**  
40x40MM open end cap  
lacquered  
Pieces  
50 pieces / bag

CL031 - Tube sheathing 30x30MM

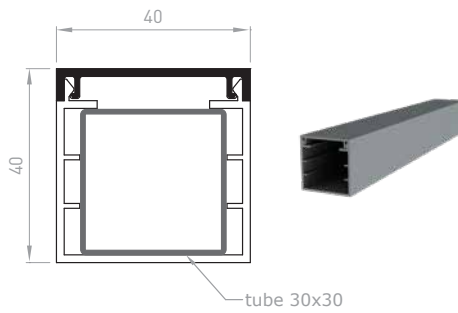

### PACK SIZES

6 bars of 6ml / pack  
208 bars of 6ml / container

Matching tips



**PIC027**  
End cap 30x30MM closed  
lacquered  
Pieces  
50 pieces / bag



**PIC028**  
End cap 30x30MM open  
lacquered  
Pieces  
50 pieces / bag



**PIC029**  
40MM sheathing key  
lacquered  
Pieces  
50 pieces / bag

Le renfort des gainages



**DI019**  
Flat 23x6MM  
20 bars of 6 ml / pack

## > THE POSTS

### CL096 - Post 90x90MM

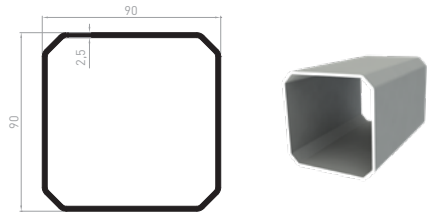

#### PACK SIZES

2 bars of 6ml / pack  
35 bars of 6ml / container

#### Matching tips

**PIC053**  
Mouthpiece 90x90MM  
lacquered  
Pieces  
10 pieces / bag



**PIC054**  
Mouthpiece 90x90MM  
lacquered  
Pieces  
50 pieces / bag



### CL097 - Post 120x120MM

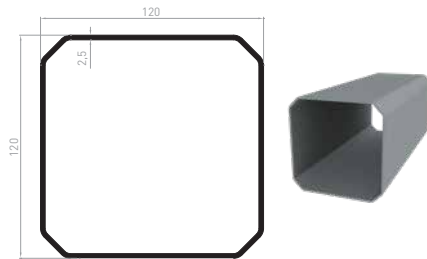

#### PACK SIZES

2 bars of 6ml / pack  
20 bars of 6ml / container

#### The corresponding tip

**PIC069**  
Mouthpiece 120x120MM  
lacquered  
Pieces  
10 pieces / bag



### CL127 - Post 165x165MM

For more information on the SISTÄDEL post, see pages 38-39

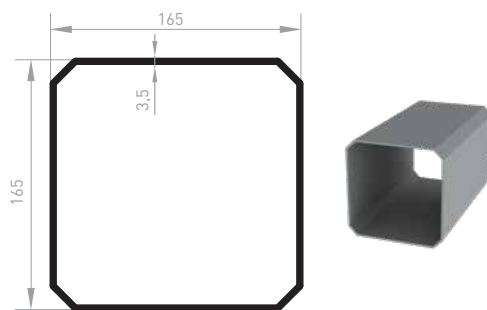

#### PACK SIZES

1 bar of 6ml / pack

#### The corresponding tip

**PIC071**  
Mouthpiece 200x200MM  
lacquered  
Pieces  
5 pieces / bag

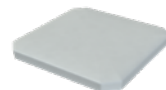

### CL057 - Post 200x200MM

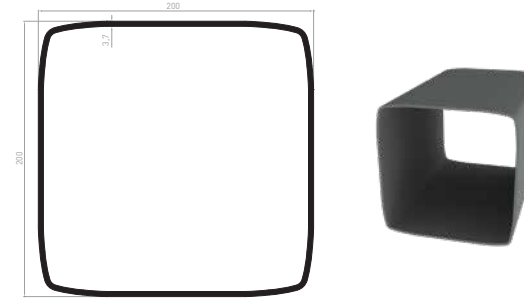

#### PACK SIZES

1 bar of 6ml / pack

#### The corresponding tip

**PIC042**  
Mouthpiece 200x200MM  
Pièce

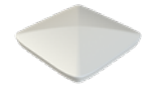

### CL095 - half-post 90x40MM

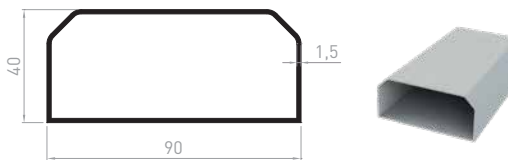

#### PACK SIZES

5 bars of 6ml / pack

#### The corresponding tip

**PIC063**  
half tip  
lacquered  
Pieces  
10 pieces / bag



## > PANELS AND REINFORCEMENTS

### VB002 - Panel 300x24MM - pitch of 60MM

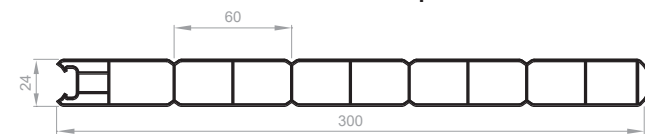

#### PACK SIZES

3 bars of 6ml / pack  
42 bars of 6 ml / container

### VB003 - Panneau 240x24MM - pitch of 60MM

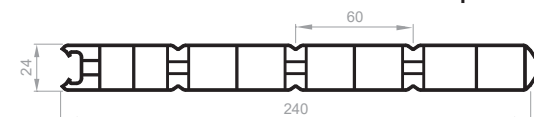

#### PACK SIZES

3 bars of 6ml / pack  
56 bars of 6 ml / container



**VB009 - Panel 240x24MM - pitch of 120MM**

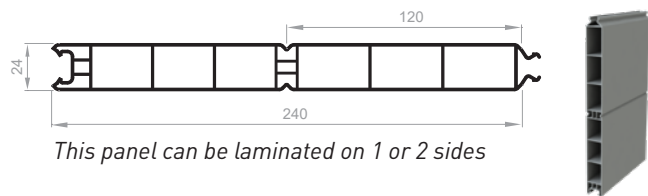

This panel can be laminated on 1 or 2 sides

**PACK SIZES**

3 bars of 6ml / pack  
56 bars of 6 ml / container

**VB017 - Panel 200x24MM - pitch of 200MM**

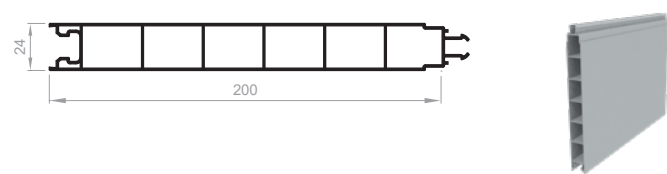

**PACK SIZES**

3 bars of 6ml / paquet  
63 bars of 6 ml / container

List of rushes and accessories for panels



**VB018**  
24MM ring (for VB017)  
10 bars of 6 ml / pack

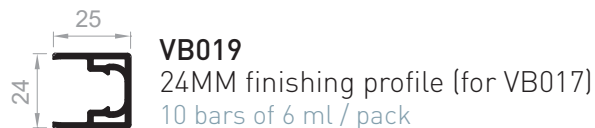

**VB019**  
24MM finishing profile (for VB017)  
10 bars of 6 ml / pack

The corresponding reinforcements and finishing profiles : VB002 - VB003 - VB009 - VB0017

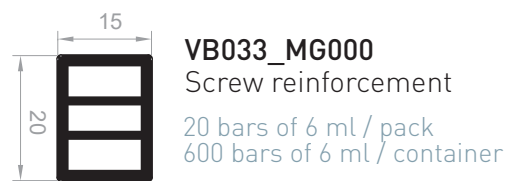

**VB033\_MG000**  
Screw reinforcement  
20 bars of 6 ml / pack  
600 bars of 6 ml / container

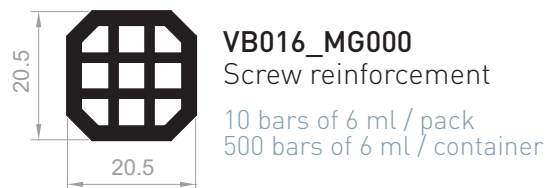

**VB016\_MG000**  
Screw reinforcement  
10 bars of 6 ml / pack  
500 bars of 6 ml / container

**VB006 - Panel 300x28MM - pitch of 60MM**

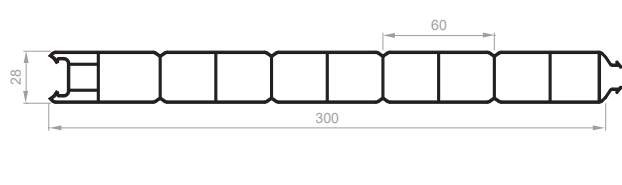

**PACK SIZES**

3 bars of 6ml / pack  
36 bars of 6 ml / container

The corresponding reinforcements



**VB010\_MG000**  
Screw reinforcement  
5 bars of 6ml / pack  
500 bars of 6ml / container



**ME089\_MG000**  
Screw reinforcement  
20 bars of 6ml / pack  
900 bars of 6ml / pack

Corresponding reinforcements for 24 mm and 28 mm panels



**RF025\_BRUT**  
REINFORCEMENT 25X25MM  
FOR 24MM AND 28MM PANELS  
FOR CL080 AND CL081 BOARDS  
FOR BOARD VB006  
10 bars of 1.5ml / pack  
Bar of 6.5ml



**RF024\_BRUT**  
REINFORCEMENT 20X20MM  
FOR 24MM AND 28MM BOARDS  
FOR BOARDS VB017 / VB002 / VB003 /  
VB009  
10 bars of 1.5ml / pack  
10 bars of 6.5ml / pack

**THE FINISHING U'S**

**CL020 - U finish 24x18x2MM**

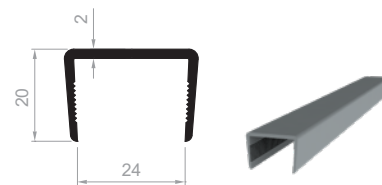

**PACK SIZES**

Plaxed  
10 bars of 6ml / pack  
Mass-coloured  
20 bars of 6 ml / pack

**CL024 - U finish 24x10x1.2MM**



**PACK SIZES**

Plaxed  
10 bars of 6ml / pack  
Mass-coloured  
20 bars of 6 ml / pack

**CL063 - U finish 28x18x2MM**

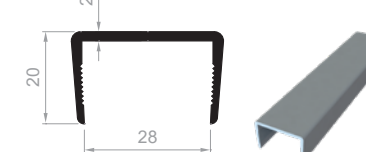

**PACK SIZES**

Plaxed  
5 bars of 6ml / pack  
Mass-coloured  
20 bars of 6 ml / pack

**THE FILLING BLADES**

**CL080 - Ripper blade 135x30MM**

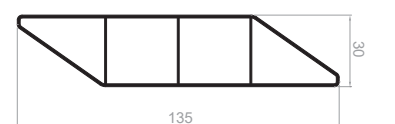

**PACK SIZES**

5 bars of 6ml / pack  
Plaxed  
98 bars of 6ml / pack  
Mass-coloured  
102 bars of 6 ml / pack

**CL081 - Blade 160x30MM**

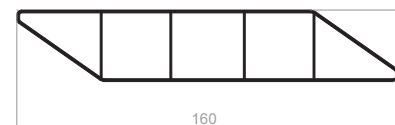

**PACK SIZES**

5 bars of 6ml / pack  
77 bars of 6 ml / container

**CL082 - Blade 160x28MM**



**PACK SIZES**

5 bars of 6ml / pack  
68 bars of 6 ml / container

Reinforcement



**RF025**  
Reinforcement 25x25MM  
10 bars of 1.5ml / pack  
Bar of 6.5ml

# Gate and Fence on the wall

Filling profiles



Boards and Bars

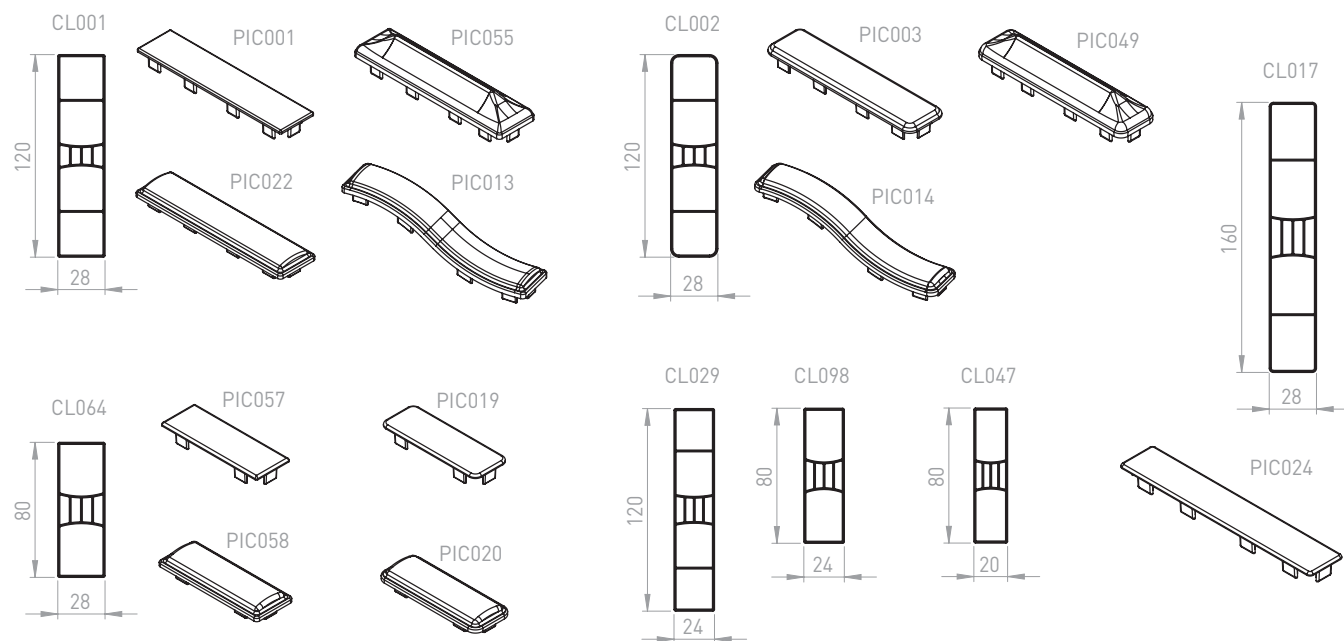

Panels

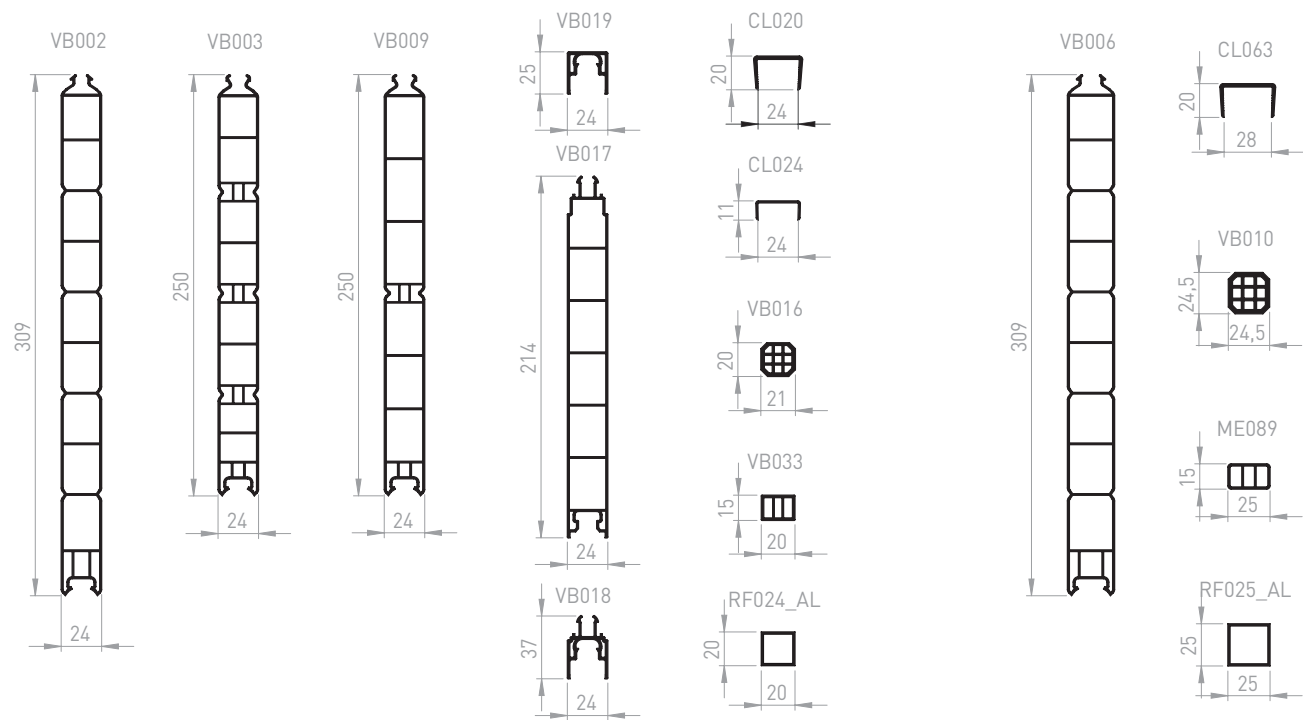

Privacy fence

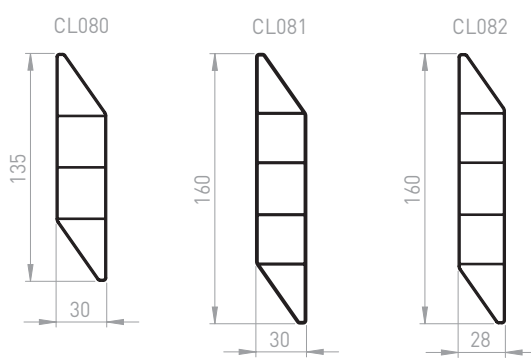

*\*We recommend the use of reinforcements in the boards and filler strips to avoid any deformation.*

# Gate and Fence on the wall

Filling profiles



Poteaux à défoncer

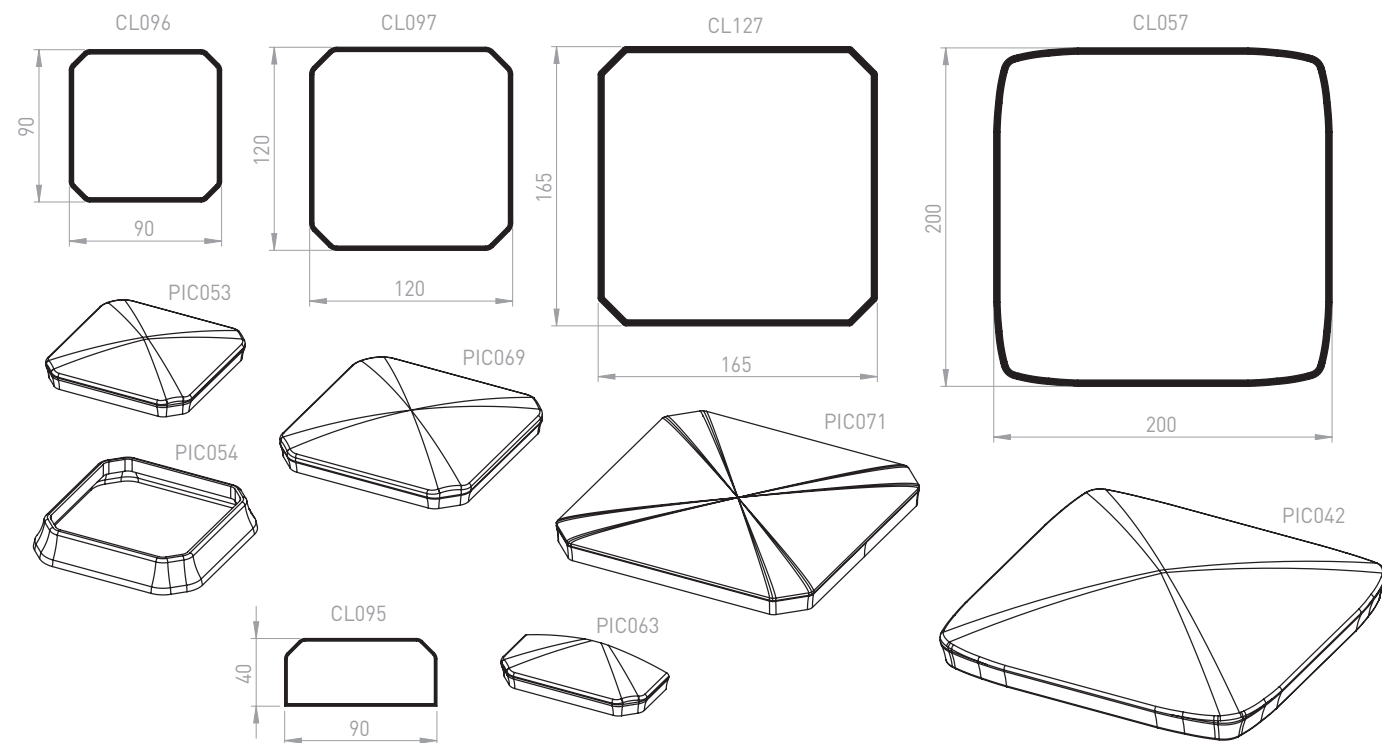

Battements Gainages

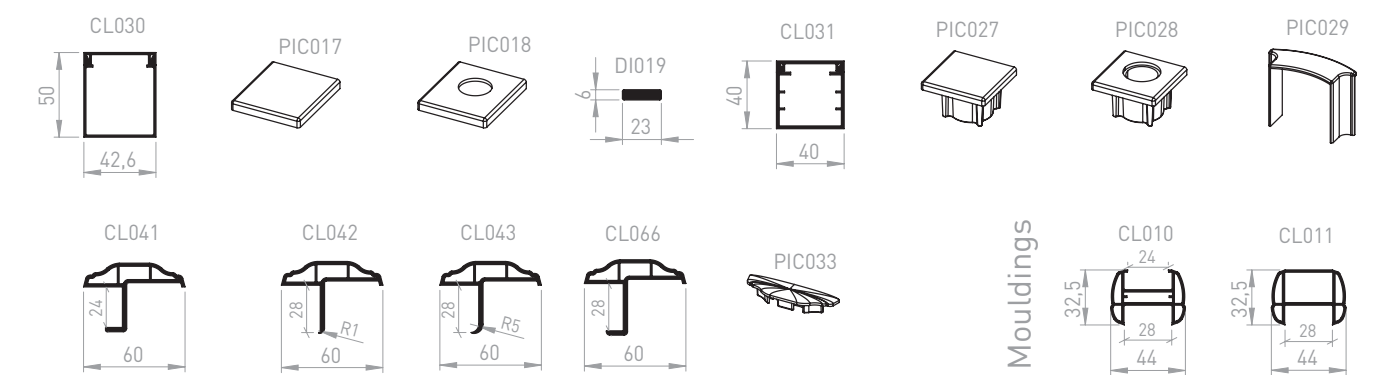

Chapeaux de gendarmes et Cintres

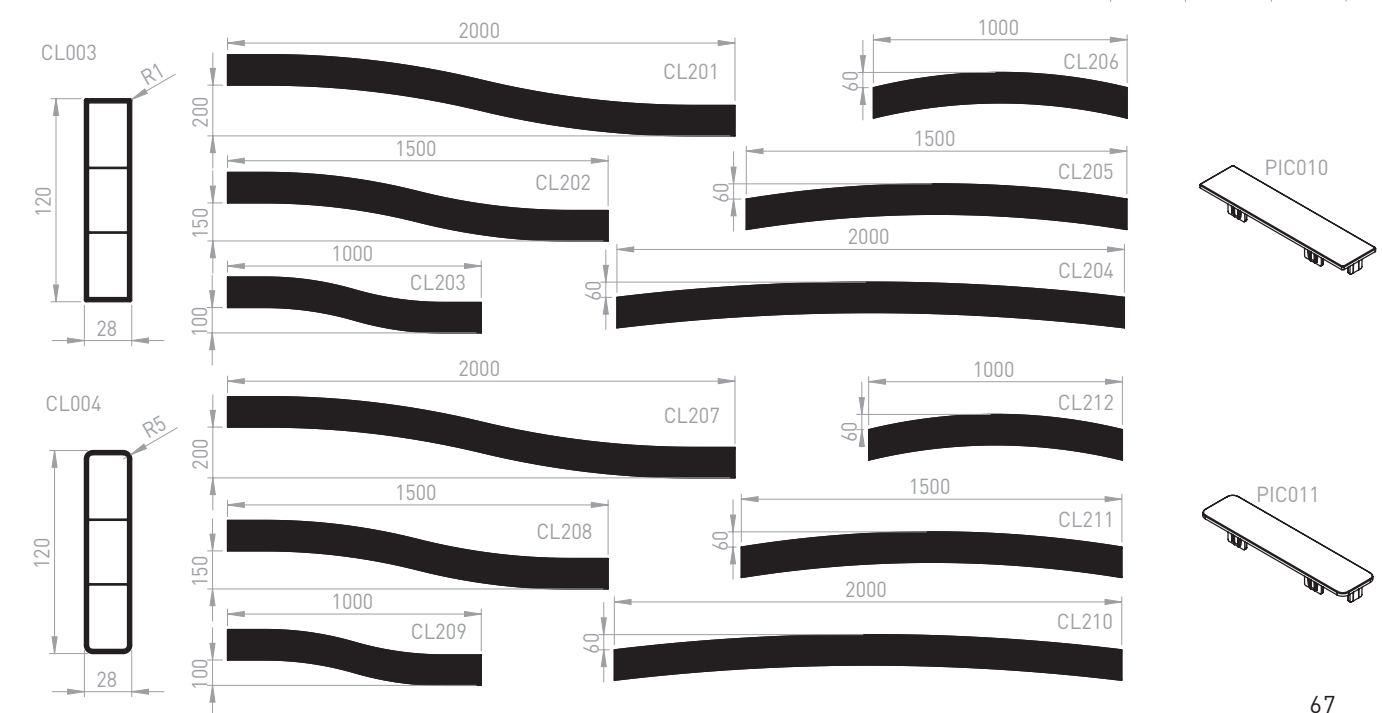





**I – CHAMP D'APPLICATION**

Les ventes de la société GEPLAST (ci-après « notre Société » ou « nous ») sont soumises aux présentes conditions générales, auxquelles le client adhère sans réserve et qui prévalent sur toute condition d'achat et toute clause contraire indiquées sur les documents du client, sauf dérogation formelle et expresse de notre part.

Aucun retard ni aucune omission de notre part à nous prévaloir à un moment donné de l'une quelconque des présentes conditions ne peut être interprété comme une renonciation à nous prévaloir de ladite condition. Si l'une des conditions prévues aux présentes venait à être annulée ou rendue inopposable au client, en tout ou partie, ce dernier resterait tenu de l'ensemble des autres conditions.

**II – FORMATION DU CONTRAT**

Toute commande reçue du client, proposition ou devis émis par notre Société, doit faire l'objet d'une confirmation de commande de notre part, acceptée par le client.

C'est cette confirmation de commande qui nous engage, ainsi que le client, et fait foi en cas de contestation ultérieure. Seule la confirmation de commande acceptée par les deux parties peut déroger aux présentes conditions générales. En cas de contradiction avec la confirmation de commande, seule cette dernière prévaut.

Nos plans, dessins, études, photos, brochures, catalogues, etc., restent notre entière propriété.

**III – LIVRAISON - DELAIS**

Sauf mention contraire dans notre confirmation de commande, les délais de livraison ne sont qu'indicatifs et sans garantie. Aucune indemnisation ou résolution du contrat ne pourra être consentie en cas de retard.

Toutefois, en cas de retard de plus 8 semaines après la date indicative de livraison, non imputable à un cas de force majeure, le client pourra demander la résolution de la vente, sans pénalité de part et d'autre après mise en demeure restée infructueuse. Les acomptes versés devront être restitués au client sous huit jours.

Le client accepte que la livraison des produits commandés soit globale, ou seulement partielle sous réserve de l'en informer préalablement.

En toute hypothèse, l'exécution de la commande ne peut intervenir que si le client est à jour de ses obligations envers notre Société.

**IV – LIVRAISON - TRANSFERTS DES RISQUES - RETOURS**

La livraison de nos marchandises et de leurs emballages est réputée effectuée dans nos entrepôts. Le transfert des risques au client s'effectue dès l'enlèvement des marchandises.

Le client dispose d'un délai de 10 jours à compter de la mise à disposition des marchandises pour en prendre possession. Passé ce délai, les risques lui seront transférés, et le client sera redevable de pénalités de stockage égales à 1% du prix des marchandises, par jour de retard, sans préjudice de tous autres dommages et intérêts justifiés.

Lors de la réception, le client ou son représentant est tenu de vérifier l'état des marchandises et leur conformité avec la commande.

Notre Société est dégagée de toute responsabilité concernant des erreurs de quantité, avaries ou vices apparents constatés après la signature du bon de livraison et/ou la lettre de voiture.

La défectuosité partielle d'une livraison ne peut justifier son rejet total.

A l'exception des cas de non-conformité ou de vice reconnus, les produits ne pourront être repris. Aucun produit ne peut être renvoyé sans notre accord écrit préalable et nos instructions pour la réexpédition.

Pour les profils livrés par containers métalliques, il est rappelé que les containers restent la propriété inaliénable de notre Société et doivent nous être restitués. A défaut de restitution, le coût des containers (350 €HT/pièce) sera facturé au client.

**V – TRANSPORT**

A défaut de convention contraire, le transport des marchandises est à la charge du client.

Si le transport est effectué par nos soins ou confié à un tiers transporteur, il est expressément admis que c'est à la demande du client et à ses risques et périls, y compris lorsque le prix est stipulé franco. Il appartient donc au client de prendre toute disposition en cas d'avaries ou de manquants, conformément aux dispositions des articles L133-3 et suivants du Code de Commerce.

Sauf dérogation formelle et expresse de notre part, aucune clause ne pourra être considérée comme dérogeant aux règles susvisées.

**VI – GARANTIE – RESPONSABILITE**

Conformément aux articles 1641 et suivants du Code civil, nos produits bénéficient de la garantie légale des vices cachés, ainsi que celle relative aux vices apparents dès lors que, s'agissant de ces derniers, ceux-ci auront été signalés par le client ou son représentant lors de la réception.

En cas de produits tiers intégrés à nos propres produits, notre Société ne saurait accorder plus de garantie que celle due et consentie par les fournisseurs et fabricants desdits produits tiers.

Dans tous les cas, si la non-conformité ou le vice est reconnu, la responsabilité de notre Société se limitera, à notre choix, soit à l'échange ou à la remise en état du produit ou de l'élément non-conforme ou défectueux, soit au remboursement de la commande, à l'exclusion de toute indemnité ou dommages-intérêts, pour quelque cause que ce soit, notamment pour frais de main d'œuvre, démontage, remontage, immobilisation, frais de transport, etc.

La garantie ne joue pas en cas de conditions de stockage ou mise en œuvre non conformes aux règles de l'art, inappropriées ou contraires à nos directives, en cas de négligence, de mauvais entretien ou utilisation inappropriée ou non conforme à la destination de nos produits.

**VII – PRIX - CONDITIONS DE PAIEMENT**

Nos prix sont stipulés hors taxes et hors emballage et nos marchandises sont toujours facturées au prix en vigueur au jour de la confirmation de commande, la TVA étant en sus au taux en vigueur à la date de la facturation. Les frais de paiement tels que frais de virement, frais de conversion, frais de douane, sont à la charge du client.

Les factures sont payables à notre siège social à 30 jours nets date d'expédition, sauf convention expresse contraire de notre part. Si une commande s'exécute en plusieurs livraisons, les factures afférentes à chacune des expéditions sont payables au fur et à mesure de leur émission sans attendre l'exécution entière de la commande.

De plus, conformément aux dispositions de l'article L.441-10 du Code de commerce, tout retard de règlement ou toute prorogation d'échéance emporte de plein droit l'application d'un intérêt de retard calculé prorata temporis, égal au taux d'intérêt appliqué par la Banque centrale européenne à son opération de refinancement la plus récente majoré de 10 points de pourcentage.

En outre, tout retard de paiement non autorisé par notre Société entraîne l'exigibilité, à titre de clause pénale pour retard, d'une indemnité fixée forfaitairement à 10 % du prix, outre le versement de l'indemnité forfaitaire de recouvrement de 40 € prévue à l'article L.441-10 du Code de commerce et qui pourra être majorée des frais de recouvrements réels exposés (si supérieurs à cette dernière).

**VIII – IMPAYES - CLAUSE RESOLUTOIRE**

En cas de défaut de paiement, quarante-huit heures après une mise en demeure restée infructueuse, la vente sera résiliée de plein droit si bon nous semble et notre Société pourra demander restitution des produits, sans préjudice de tous autres dommages et intérêts. La résolution frappera non seulement la commande en cause mais aussi toutes les commandes impayées antérieures, qu'elles soient livrées ou en cours de livraison et que le paiement soit échu ou non.

En cas de paiement par effet de commerce, le défaut de retour de l'effet sera considéré comme un refus d'acceptation assimilable à un défaut de paiement. De même, lorsque le paiement est échelonné, le non-paiement d'une seule échéance entraînera l'exigibilité immédiate de la totalité de la dette sans mise en demeure.

Dans tous les cas qui précèdent, les sommes qui seraient dues pour d'autres livraisons ou pour toute autre cause deviendront immédiatement exigibles si notre Société n'opte pas pour la résolution des commandes correspondantes. Notre Société pourra également, si bon lui semble, suspendre l'exécution de toute commande en cours.

**IX – DETERIORATION DE LA SOLVABILITE OU DE LA SITUATION FINANCIERE DU CLIENT**

En cas de détérioration de la solvabilité ou de la situation financière du client, nous pouvons, à notre choix, soit annuler la commande, soit exiger le paiement à l'avance ou encore exiger des garanties complémentaires. En cas d'ouverture d'une procédure collective contre l'acheteur, nous pourrions annuler la commande dans la mesure où le droit local applicable à cette procédure le permet.

**X – FORCE MAJEURE - IMPREVISION**

Tout cas de force majeure entraînera de plein droit la suspension des délais d'exécution de nos engagements et nous donnera la faculté, le cas échéant, de les résilier.

En aucun cas notre responsabilité ne pourra être engagée en cas de force majeure nous mettant dans l'impossibilité de livrer ou d'exécuter la commande.

La force majeure telle qu'entendue au sens des présentes inclut notamment, de manière non exhaustive : la pandémie, la guerre, la mobilisation, la grève totale ou partielle, le lock-out, le retard de nos fournisseurs, le bris de machine, les difficultés d'approvisionnement en matières premières, composants, équipements ou en énergie, l'incendie ou tout autre événement dont nous n'aurions pas la maîtrise, de nature à empêcher ou réduire les fabrications ou les livraisons.

En cas de modification importante des conditions économiques en vigueur lors de notre acceptation d'une commande, de nature à rendre l'exécution excessivement onéreuse pour nous (notamment le prix de la matière première) nous nous réservons le droit de renégocier les conditions de cette commande et de la résilier en cas d'impossibilité d'accord.

**XI – RESPECT DE NOS PRECONISATIONS**

L'utilisation conforme des produits commercialisés par notre Société nécessite le respect scrupuleux des préconisations notamment de sélection, de stockage, de pose, d'utilisation et d'entretien stipulées dans nos notices, guides, cahiers, catalogues, fiches d'entretien et autres documents techniques.

Ces documents sont consultables librement sur notre site internet [www.geplast.fr](http://www.geplast.fr)

Ces documents peuvent également être remis au client sur simple demande de sa part.

Le client s'engage à les porter à l'attention des utilisateurs intermédiaires et finaux.

En toute hypothèse, le client s'engage à ne pas entreprendre une quelconque utilisation ou action sur les produits commercialisés sans s'être enquis préalablement des éventuelles préconisations relatives auxdits produits. Le non-respect de ces préconisations s'oppose à tout remplacement, réparation, remboursement ou indemnisation d'aucune sorte.

Ces préconisations sont notamment les suivantes, sans caractère d'exhaustivité, et sans pouvoir se substituer à une étude attentive et au respect scrupuleux des documents techniques relatifs à chaque produit, et en cas de doute, à en référer préalablement à notre Société :

**Vérification de la compatibilité des produits et adéquation aux besoins du client**

Le client se doit de vérifier l'adéquation de nos produits et de leurs spécificités techniques à ses besoins, attentes et aux utilisations qu'il compte en faire.

En cas d'utilisation prévue de nos produits en combinaison ou incorporation avec d'autres produits dont nous n'avons pas préalablement garanti la compatibilité, que ces produits proviennent de notre Société ou de tiers, il appartient au client de s'assurer préalablement de l'adéquation et de la compatibilité des produits entre eux et plus généralement de la faisabilité technique de l'opération, dans des conditions raisonnables.

**Vérification de l'état des produits avant utilisation et test de mise en œuvre**

Les produits commercialisés par notre Société, qu'ils soient composés de matière synthétique (par exemple le PVC ou ABS), végétale ou hybride (par exemple la gamme Loryza) peuvent présenter des nuances de réalisation, notamment dans leur apparence (différences de teintes, imperfections des matériaux, etc.) et des nuances au niveau des longueurs.

En cas de mise en œuvre spécifique des produits, il appartient au client de procéder à des tests préalables.

**Conditions de stockage et d'entretien des produits**

Les produits doivent être stockés et entretenus dans des conditions normales et usuelles permettant d'assurer la préservation de leur structure, propriétés et apparence, notamment à l'égard des aléas climatiques, atmosphériques, de température, de luminosité ou autre, quelle que soit leur source, et en tout cas conformément à nos préconisations spécifiques lorsque celles-ci existent. De façon générale, les produits doivent être stockés à l'abri du soleil, des intempéries et de l'humidité.

Notamment, pour le stockage, les produits doivent être empilés sur une surface sèche et plane, dans un endroit frais et bien ventilé, à l'abri de la lumière, de manière à ne subir aucune déformation ou décoloration.

Les profils, composée à 100% de PVC, doit être entretenue à l'eau tiède savonneuse avec une éponge douce non abrasive et rincée à l'eau claire. Aucun solvant, acide, produit à base d'acétone ou chloré ne doit être utilisé. Pour le stockage, les kits cartons comme les paquets doivent être posés sur une surface sèche et plane, dans un endroit bien ventilé de manière à ne subir aucune déformation.

**XII - DROIT DE PUBLICITE**

Toute utilisation par le client de l'une de nos marques ou dénomination sociale sera subordonnée à notre accord écrit et préalable.

**XIII – DONNEES PERSONNELLES**

Dans le cadre des relations contractuelles avec le client, notre Société a recours à des moyens informatiques destinés à gérer plus facilement la commande du client, à satisfaire aux obligations légales ou réglementaires et à adresser les documents commerciaux au client. Certaines des données ainsi collectées, requises pour la conclusion ou la bonne exécution du ou des contrat(s), peuvent concerner une ou plusieurs personnes physiques identifiées ou identifiables agissant dans le cadre de leur activité professionnelle. Elles répondent dans ce cas à la qualification de données personnelles au sens de la réglementation nationale et européenne en vigueur. Notre Société est alors considérée comme le Responsable du Traitement

Ce faisant, notre Société s'engage à respecter en toutes circonstances la réglementation applicable au traitement de données à caractère personnel, et en particulier le règlement (UE) 2016/679 du Parlement européen et du Conseil du 27 avril 2016 applicable à compter du 25 mai 2018 (ci-après « le RGPD ») et la loi n°78-17 du 6 janvier 1978 relative à l'informatique, aux fichiers et aux libertés.

Notre Société s'engage également à ne faire appel ou à ne collaborer qu'avec des prestataires ou partenaires s'y conformant également.

Conformément à la réglementation, les données sont conservées le temps de la relation commerciale entre notre Société et le client puis pour une durée de 3 années après l'expiration de celle-ci, à des fins statistiques, ceci sans préjudice d'éventuelles obligations légales ou réglementaires d'archivage de données lorsque celle-ci existent et de la conservation rendue nécessaire à l'établissement de la preuve d'un droit ou d'un contrat qui peuvent être archivés conformément aux dispositions du Code de commerce.

Les personnes physiques objets du traitement disposent en toute hypothèse, relativement aux données les concernant, d'un droit d'accès, de rectification, d'effacement, de limitation, d'opposition, de portabilité, du droit de ne pas faire l'objet d'une décision individuelle automatisée (y compris le profilage) et d'un droit de recours auprès de la CNIL.

**XIV - RESERVE DE PROPRIETE**

LES PRODUITS VENDUS RESTENT NOTRE PROPRIETE JUSQU'AU PAIEMENT EFFECTIF DE L'INTEGRALITE DU PRIX EN PRINCIPAL ET ACCESSOIRE. A CET EGARD, NE CONSTITUE PAS UN PAIEMENT AU SENS DE LA PRESENTE CLAUSE, LA REMISE D'UNE TRAITE OU DE TOUT AUTRE TITRE CREANT UNE OBLIGATION DE PAYER.

LE DEFAUT DE PAIEMENT DE L'UNE QUELCONQUE DES ECHEANCES PEUT ENTRAINER LA REVENDICATION DES PRODUITS.

LE CLIENT S'ENGAGE JUSQU'A COMPLET PAIEMENT DU PRIX, A PEINE DE REVENDICATION IMMEDIATE DES PRODUITS PAR NOTRE SOCIETE, A NE PAS TRANSFORMER NI INCORPORER LESDITS PRODUITS, NI A LES REVENDRE OU LES METTRE EN GAGE.

EN TOUTE HYPOTHESE, LES PRODUITS ENCORE EN POSSESSION DU CLIENT SONT REPUTES ETRE CEUX IMPAYES.

LE CLIENT S'ENGAGE EN OUTRE A NOUS PREVENIR IMMEDIATEMENT DE SON ETAT DE CESSATION DE PAIEMENT, A PROCEDER OU LAISSER PROCEDER DES L'OUVREMENT DE LA PROCEDURE COLLECTIVE DE REDRESSEMENT OU LIQUIDATION JUDICIAIRE AU CONSTAT D'EXISTENCE DANS SON STOCK DE MARCHANDISES IMPAYEES NOUS APPARTENANT ET A NOUS FOURNIR TOUT RENSEIGNEMENT PERMETTANT D'EXERCER LA REVENDICATION A L'EGARD DES SOUS-ACQUEREURS.

CES DISPOSITIONS NE FONT PAS OBSTACLE AU TRANSFERT AU CLIENT, DES LA LIVRAISON, DES RISQUES DE PERTE ET DETERIORATION DES PRODUITS VENDUS AINSI QUE DES DOMMAGES QU'ILS POURRAIENT OCCASIONNER.

**XV – LOI APPLICABLE - REGLEMENT DES LITIGES**

TOUTES LES CONTESTATIONS RELATIVES A NOS VENTES A A L'EXECUTION OU A L'INTERPRETATION DE NOS CONDITIONS GENERALES DE VENTE SONT SOUMISES AU DROIT FRANÇAIS ET SERONT DE LA COMPETENCE EXCLUSIVE DU TRIBUNAL DE COMMERCE DE NANTES (FRANCE), MEME EN CAS D'APPEL EN GARANTIE OU DE PLURALITE DE DEFENDEURS.

Date :

Nom, Prénom :

Signature précédée de la mention « Lu et approuvé »



# GEPLAST

*Outdoor*

**RENDEZ-VOUS SUR  
WWW.GEPLAST.FR**

GEPLAST SAS  
Z.I. Actipole Nord 249  
6, rue de Beauséjour  
Saint André de la Marche  
49450 SEVREMOINE  
Tél : 02.41.49.80.90  
Fax : 02.41.46.42.07

*Document non contractuel. Nous nous réservons le droit à tout moment, dans un souci d'évolution de nos profilés, d'apporter toutes modifications que nous jugeons utiles.*